

Best viewed in landscape mode



THE

X1



THE BMW X1.

RETURN BY CLICKING [🏠](#)
SELECT A TOPIC BELOW TO EXPLORE:



FEATURED MODEL. BMW X1 xDRIVE20i xLINE:

BMW TwinPower Turbo four-cylinder petrol engine, 178hp (131kW), 19" light alloy Y-spoke style 580 wheels in Bicolour, Storm Bay metallic paint, Sport seats, Dakota leather in Oyster with Grey highlight, Fine Oak matt wood interior trim with Pearl Chrome finisher.

Content correct at time of publishing (as of November 2020). Prices and technical data subject to change. The models shown on these pages may feature optional equipment. Standard equipment may also vary depending on engine variant. For further details, please contact your local BMW Centre.



"THE BMW X1 IS ONE OF THE BEST FAMILY SUVS AROUND. IT'S VERY POLISHED INSIDE, WITH A CLASSY INTERIOR THAT OFFERS PLENTY OF SPACE, AND IT'S GREAT TO DRIVE, TOO."

What Car?

[Read the full review](#)





**FOR THE EVERY DAY.
FOR EVERY JOURNEY.
SPACE TO AMAZE.**

M SPORT.



The BMW X1 M Sport model is shown above in Misano Blue metallic paint.

■ Standard equipment □ Optional equipment

M SPORT.

In addition / replacement to SE models

EXTERIOR

- 18" M light alloy Double-spoke style 570 M wheels
- Exterior mirrors – electrically folding with anti-dazzle
- Exterior trim, High-gloss Shadowline
- Roof rails, High-gloss Shadowline
- Kidney grille, Chrome with 14 Black vertical bars
- M aerodynamic bodystyling, comprising:
 - Body colour wheel arch trims and side sills
 - Front bumper with enlarged air intakes

INTERIOR

- Seat heating, front
- Sport seats, front
- Dakota leather upholstery
- Extended LED lighting
- Headlining, Anthracite
- Interior trim, Aluminium Hexagon with Estoril Blue finisher
- M Sport leather steering wheel in Nappa leather
- Remote key with M Sport-specific detailing
- Door sill finishers with M designation, front
- Contrast stitching on centre console in Blue, Silver, Grey or Brown to match seat upholstery

SAFETY & TECHNOLOGY

- M Sport suspension (excludes xDrive25e)



xLINE.



The BMW X1 xLine model is shown above in Storm Bay metallic paint.

■ Standard equipment □ Optional equipment

xLINE.

In addition / replacement to SE models

EXTERIOR

- 18" light alloy Y-spoke style 579 wheels, Bicolour
- Exterior mirrors – electrically folding with anti-dazzle
- Exterior trim, Satin Aluminium
- Roof rails, Satin Aluminium
- Kidney grille with 14 matt Aluminium fronted (with Black matt sides) vertical bars
- Front air inlets in Black matt with Silver matt finisher

INTERIOR

- Seat heating, front
- Dakota leather upholstery with perforation and contrast stitching
- Extended lighting
- Interior trim, High-gloss Black with Pearl Chrome finisher
- LED ambient lighting in door trim
- Remote control with integrated key, with Pearl Chrome highlight
- Exclusive door sill finishers with BMW designation, front
- Contrast stitching on instrument panel in Silver, Grey or Brown to match seat upholstery
- Stainless steel insert on loading edge in luggage compartment

SAFETY & TECHNOLOGY

- LED headlights

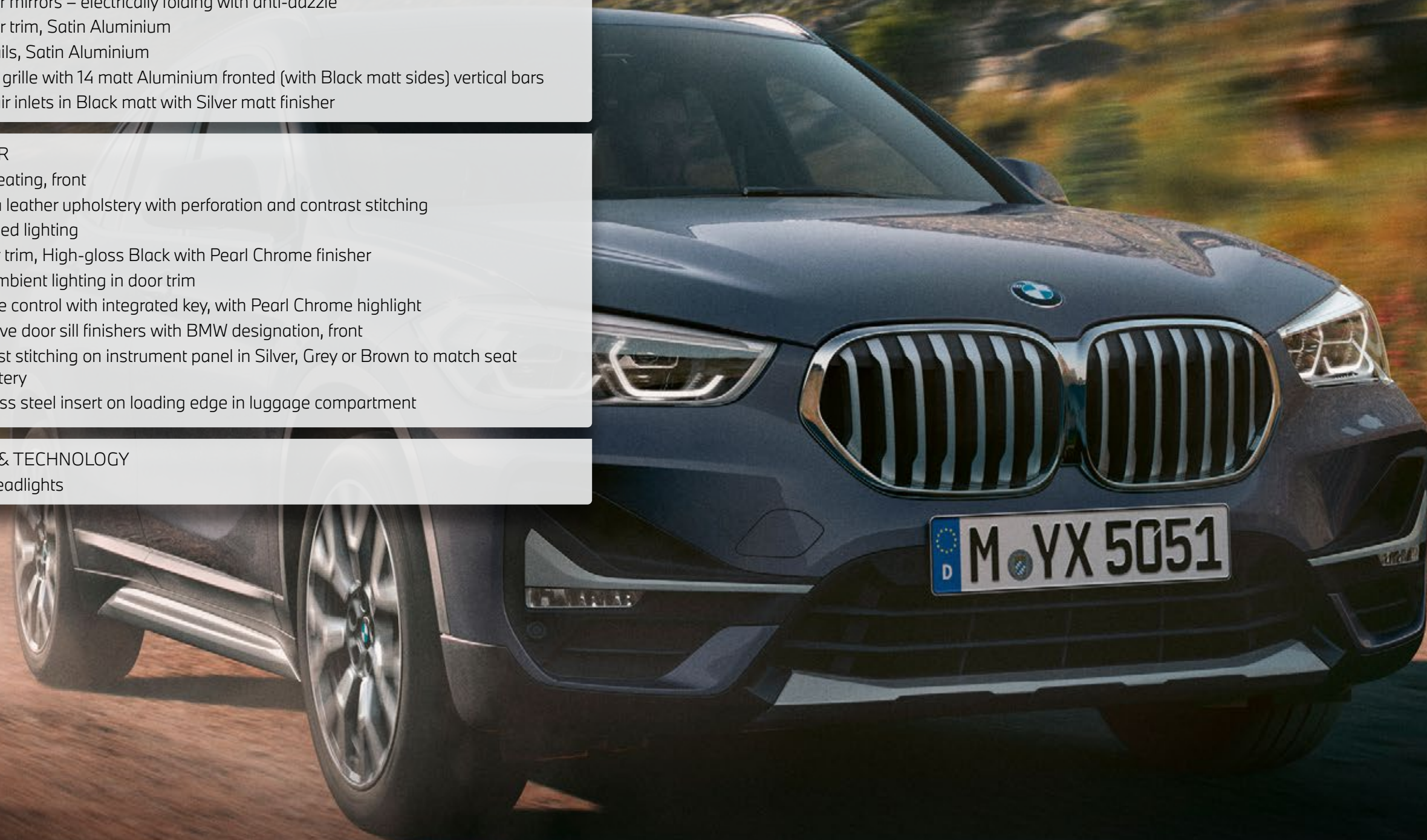

SPORT.



The BMW X1 Sport model is shown above in Sunset Orange metallic paint.

■ Standard equipment □ Optional equipment

SPORT.

In addition / replacement to SE models

EXTERIOR

- 18" light alloy Double-spoke style 578 wheels, Jet Black
- Exterior trim, High-gloss Shadowline
- Roof rails, High-gloss Shadowline
- Front air inlets with High-gloss Black finisher
- Front bumper underbody protection
- Kidney grille, Chrome with 14 Black vertical bars
- Rear bumper underbody protection in Body colour with High-gloss Black insert
- Sill cover with Body colour insert

INTERIOR

- Sport seats, front
- Nivala cloth / Sensatec upholstery
- Interior trim, High-gloss Black with Pearl Chrome finisher
- Contrast stitching on instrument panel to match seat upholstery highlight stitching
- Exclusive door sill finishers with BMW designation, front
- LED ambient lighting in door trim
- Remote control with integrated key, with Pearl Chrome highlight



SE.



The BMW X1 SE model is shown above in Phytonic Blue metallic paint.

■ Standard equipment □ Optional equipment

SE.

EXTERIOR

- 17" light alloy V-spoke style 560 wheels
- Roof rails, Black
- Dynamic brake lights
- Exhaust tailpipe – Chrome, twin, round, left and right split (sDrive20i / xDrive20i / sDrive18d / xDrive18d / xDrive20d only)
- Exhaust tailpipe – Chrome, single, round, left (sDrive18i only)
- Exterior mirrors, electrically-adjustable
- Front and rear underbody protection
- Kidney grille, Chrome with 14 Black vertical bars

INTERIOR

- Air conditioning, automatic with two-zone control
- Grid cloth upholstery
- Interior trim, Oxide Silver
- 40:20:40 manually split-folding rear seat
- Electrically-operated parking brake
- Rear-view mirror – automatically dimming
- Automatic tailgate
- Extended storage
- Sport multi-function leather steering wheel, three-spoke
- Start-Stop button with Comfort Go keyless engine start and Auto Start-Stop deactivation button

AUDIO & COMMUNICATION

- Bluetooth hands-free facility with USB audio interface
- DAB digital radio

SAFETY & TECHNOLOGY

- Apple CarPlay® preparation
- BMW ConnectedDrive Services, comprising:
 - BMW Emergency Call
 - BMW Navigation System with 8.8" touch display
 - BMW Online Services
 - BMW TeleServices
 - Real Time Traffic Information (RTTI)
 - Remote Services
- Cruise control with braking function
- LED headlights
- LED foglights, front
- Park Assist
- Park Distance Control (PDC), front and rear
- Rain sensor with automatic headlights
- Drive Performance Control
- Active Guard, featuring forward vehicle collision warning
- Seven-speed Sport Dual-clutch automatic transmission with steering wheel paddles (sDrive20i only)
- Six-speed manual transmission (sDrive18i / sDrive18d / xDrive18d only)
- Sport automatic transmission (xDrive20d / xDrive20i only)

THE BMW X1 xDRIVE25e.

Featuring innovative BMW eDrive and EfficientDynamics technologies, the BMW X1 xDrive25e provides impressive levels of performance and efficiency. Offering the best of both worlds, this Plug-in Hybrid Electric Vehicle (PHEV) combines a powerful petrol engine with an electric motor that is powered by a lithium-ion battery, overall providing an exceptional pure electric driving range with the flexibility of a combustion engine. The BMW X1 xDrive25e is everything you would expect from a BMW and more, with electrifying driving pleasure, this represents the future of the Ultimate Driving Machine.

The BMW X1 xDrive25e – plug into the future today.



Pure electric range of 30.4-32.3 miles (49-52km)*

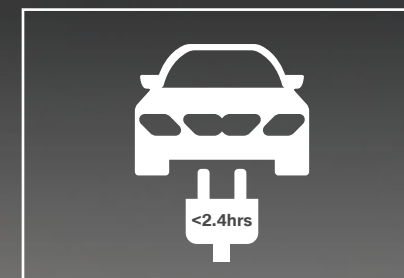

Charging time 0-80% in <2.4 hours (based on a current of 16A)^

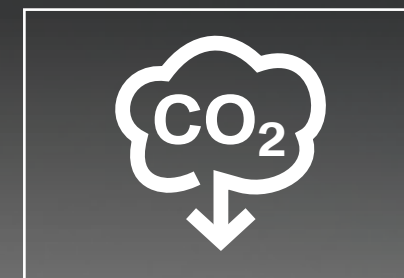

Low CO₂ emissions from 44-40g/km*



The BMW X1 xDrive25e M Sport is shown above in Mineral White metallic paint. ^ = Dependent on the local electricity infrastructure. Charging time corresponds to a charge of 80% of maximum capacity and based on a single-phase supply current of max 32A. * = These figures were obtained using a combination of battery power and fuel. The BMW X1 xDrive25e is a Plug-in Hybrid Electric Vehicle requiring mains electricity for charging. Figures shown are for comparability purposes. Only compare fuel consumption, CO₂ and electric range figures with other cars tested to the same technical procedures. These figures may not reflect real life driving results, which will depend upon a number of factors including, accessories fitted (post-registration), variations in weather, driving styles and vehicle load. The CO₂ figures have been determined according to the WLTP test. WLTP has been used as the applicable CO₂ figure from 1 April 2020 for first year vehicle tax (VED) and from 6 April 2020 for company car tax (BIK). The CO₂ figures were previously based on the NEDC equivalent.

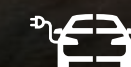

[Click here](#) to discover the key benefits of the BMW PHEV range.

■ Standard equipment □ Optional equipment

THE BMW X1 xDRIVE25e.

Featuring innovative BMW eDrive and EfficientDynamics technologies, the BMW X1 xDrive25e provides impressive levels of performance and efficiency. Offering the best of both worlds, this Plug-in Hybrid Electric Vehicle (PHEV) combines a powerful petrol engine with an electric motor that is powered by a lithium-ion battery, overall providing an exceptional pure electric driving range with the flexibility of a combustion engine. The BMW X1 xDrive25e is everything you would expect from a BMW and more, with electrifying driving pleasure, this represents the future of the Ultimate Driving Machine.

The BMW X1 xDrive25e – plug into the future today.



Pure electric range of 30.4-32.3 miles (49-52km)*

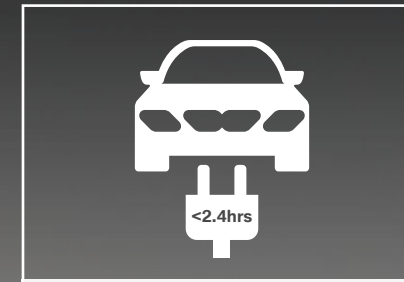

Charging time 0-80% in <2.4 hours (based on a current of 16A)^

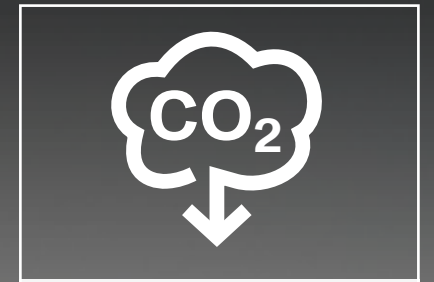

Low CO₂ emissions from 44-40g/km*

In addition / replacement to SE models

EXTERIOR

- eDrive exterior sound
- Illuminated charging socket with visual display of charge status

INTERIOR

- Pre-conditioning of interior via BMW Remote app or setting time within iDrive menu
- eDrive-specific displays in instrument cluster

SAFETY & TECHNOLOGY

- xDrive electric drive, after activation of the electric motor
- Connected eDrive Services
- eDrive Button activates AUTO eDrive, MAX eDrive and SAVE BATTERY modes
- BMW TwinPower Turbo three-cylinder petrol engine
 - Double VANOS
 - High-precision injection

BATTERY & CHARGING

- AC Fast charge cable
- Charger Cable, 5 metres in length
- Connected eDrive Services
- Lithium-ion high-voltage battery



The BMW X1 xDrive25e M Sport is shown above in Mineral White metallic paint. ^ = Dependent on the local electricity infrastructure. Charging time corresponds to a charge of 80% of maximum capacity and based on a single-phase supply current of max 32A. * = These figures were obtained using a combination of battery power and fuel. The BMW X1 xDrive25e is a Plug-in Hybrid Electric Vehicle requiring mains electricity for charging. Figures shown are for comparability purposes. Only compare fuel consumption, CO₂ and electric range figures with other cars tested to the same technical procedures. These figures may not reflect real life driving results, which will depend upon a number of factors including, accessories fitted (post-registration), variations in weather, driving styles and vehicle load. The CO₂ figures have been determined according to the WLTP test. WLTP has been used as the applicable CO₂ figure from 1 April 2020 for first year vehicle tax (VED) and from 6 April 2020 for company car tax (BIK). The CO₂ figures were previously based on the NEDC equivalent.

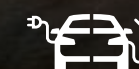

[Click here](#) to discover the key benefits of the BMW PHEV range.

■ Standard equipment □ Optional equipment

EXTERIOR COLOURS.

ALL MODELS.

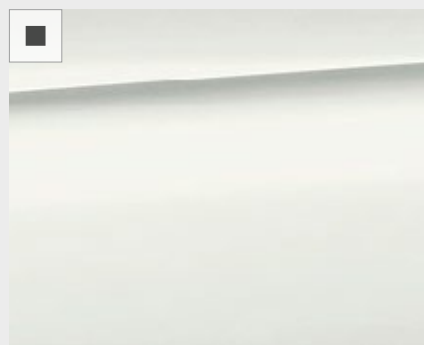

Non-metallic Alpine White



Non-metallic Jet Black

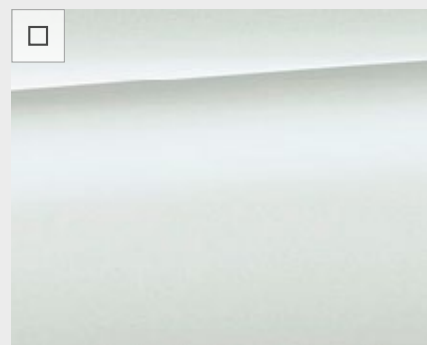

Metallic Mineral White

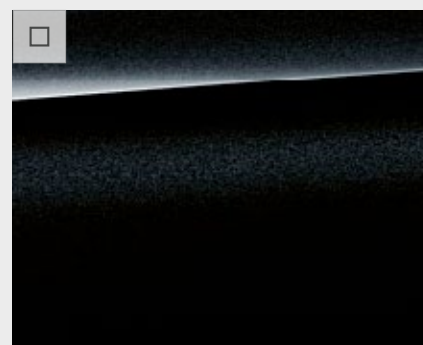

Metallic Black Sapphire



Metallic Mineral Grey

EXCLUSIVELY FOR SE, SPORT & xLINE.

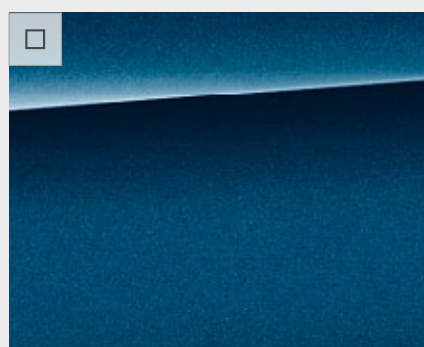

Metallic Phytonic Blue

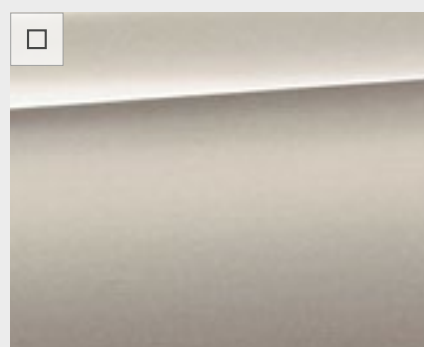

Metallic Cashmere Silver



Metallic Glacier Silver

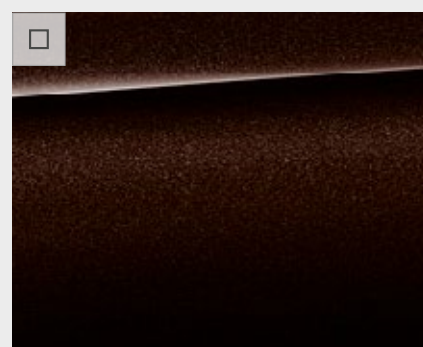

Metallic Sparkling Brown

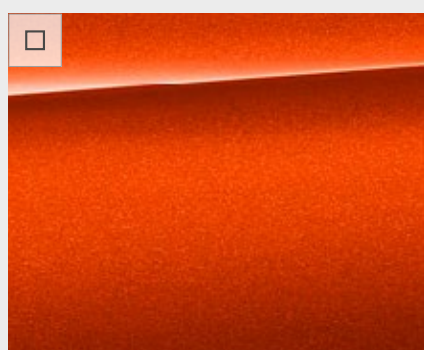

Metallic Sunset Orange

EXCLUSIVELY FOR M SPORT MODELS.

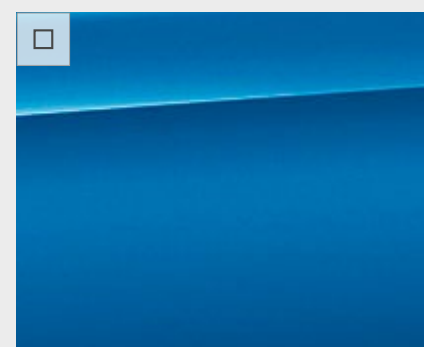

Metallic Misano Blue

EXCLUSIVELY FOR xLINE & M SPORT MODELS.



BMW Individual Storm Bay metallic

UPHOLSTERY & INTERIOR TRIMS.

CLOTH.



Grid Cloth in Anthracite
Available with
■ SE

CLOTH / SENSATEC.



Nivala Cloth / Sensatec in Anthracite with Grey highlight
Available with
■ Sport

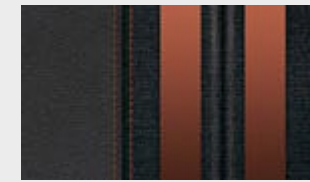

Nivala Cloth / Sensatec in Anthracite with Orange highlight
Available with
■ Sport

LEATHER.



Dakota leather in Oyster with Grey highlight and stitching
Available with
 Sport
■ xLine
■ M Sport



Dakota leather in Black
Available with
 SE



Dakota leather in Black with Blue stitching
Available with
■ M Sport

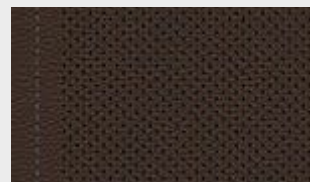

Dakota leather in Mocha with contrast stitching
Available with
 Sport
■ xLine
■ M Sport



Dakota leather in Black with Grey stitching
Available with
 Sport
■ xLine
■ M Sport

INTERIOR TRIMS.

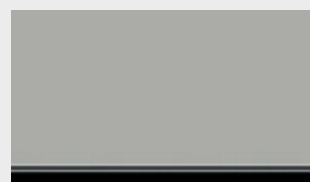

Oxide Silver with High-gloss Black finisher
Available with
■ SE

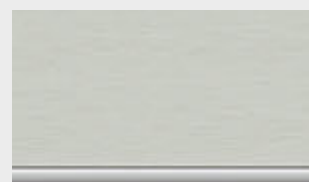

Brushed Aluminium with Pearl Chrome finisher
Available with
 Sport
 xLine
 M Sport

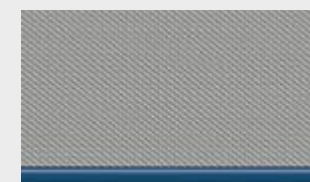

Aluminium Hexagon with Estoril Blue finisher
Available with
■ M Sport

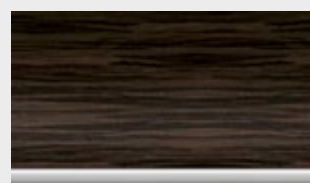

Fineline Stream wood with Pearl Chrome finisher
Available with
 Sport
 xLine
 M Sport



Fine Oak matt wood with Pearl Chrome finisher
Available with
 xLine

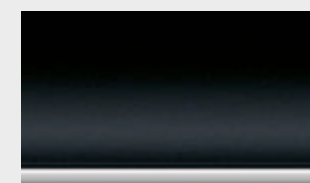

High-gloss Black with Pearl Chrome finisher
Available with
■ Sport
■ xLine
 M Sport

PACKAGES.

Optional packages offer an attractive combination of the most popular options at a reduced (combined) cost and will enhance any journey in the BMW X1.

TECHNOLOGY PACK I.

- Adaptive LED headlights
- Enhanced Bluetooth with wireless charging
- Reversing Assist camera



TECHNOLOGY PACK II.

- BMW Navigation Plus
- Head-up Display



M SPORT PRO PACK.

- 19" M light alloy Double-spoke style 816 M wheels, Bicolour
- BMW Individual High-gloss Shadowline with extended contents
- Loudspeaker system – harman/kardon
- M seat belts
- M Sport braking system
- M Sport steering
- Sun protection glass

Exclusively for M Sport models, excluding xDrive25e M Sport.



COMFORT PACK I.

- Extended lighting
- Exterior mirrors with automatic anti-dazzle
- Seat heating for the driver and front passenger



Exclusively for SE and Sport models.

COMFORT PACK II.

- Comfort Access
- Seat adjustment – front, electric with driver memory
- Steering wheel heating



OPTIONAL EQUIPMENT HIGHLIGHTS.

HEAD-UP DISPLAY.

Convenience for every journey. The Head-up Display projects information relevant to the journey onto the windscreen directly into the driver's field of vision. The display includes information such as the current speed, navigation directions, driver assistance and entertainment lists.

Exclusively available as part of Technology Pack II. Display of full content is dependent on optional equipment ordered.



LOUDSPEAKER SYSTEM – HARMAN/KARDON.

Unparalleled acoustics. The harman/kardon loudspeaker system has a 360W amplifier and multi-channel capability. With 12 speakers optimally designed to suit the interior's sound characteristics, it guarantees an exceptional music experience. Tweeters and subwoofers deliver a brilliant, powerful range of sound.

Included in M Sport Pro Pack.



EXTERIOR MIRRORS – ELECTRICALLY-FOLDING WITH ANTI-DAZZLE.

The exterior mirrors are electrically folding, with the mirror on the driver's side also featuring an automatic anti-dazzle function. The front passenger's exterior mirror features an automatic dipping parking function when reverse gear is engaged. Mirror heating, mirror memory.

Available as part of Comfort Pack I for SE and Sport models. Standard for xLine and M Sport models.



BMW NAVIGATION PLUS.

BMW Navigation Plus features a 10.25" Touch Display and instrument cluster with 5.7" TFT display. Operation is via the iDrive Controller, direct selection buttons, six or eight programmable favourites buttons, Voice Control or the Touch function on the Control Display.

Exclusively available as part of Technology Pack II.



PANORAMIC GLASS SUNROOF.

The Panoramic glass sunroof has an automatic integral wind deflector, heat-reflecting glass for sun protection and an independently-sliding headlining panel (colour matched to headlining).

Included as part of Comfort Pack I for SE and Sport models. Standard for xLine and M Sport models.



EXTENDED LIGHTING.

Extended lighting includes various LED light sources, both interior and exterior, for extra convenience and interior ambience. The colour of lights on certain parts of the interior of the vehicle can be changed.

Included as part of Comfort Pack I for SE and Sport models. Standard for xLine and M Sport models.



TOWBAR, DETACHABLE.

The detachable towbar can also be concealed. It has a 13-pin European-style trailer socket and convertor/adaptor to 7-pin. Includes Trailer Stability Control.

Not with Bike rack preparation.



STEERING WHEEL HEATING.

At the touch of a button, the Steering wheel heating quickly warms up the rim to a pleasant temperature.

Exclusively available as part of Comfort Pack II.



BMW CONNECTED DRIVE.

The BMW ConnectedDrive Services & Apps are on hand to make sure you have more time for the important things in life. Various innovations by BMW make things more convenient for you every day – whenever you want.

□ **Amazon Echo** gives you the ability to communicate with your vehicle using Voice Control and access your schedule from home.



□ **Door to door guidance** provides detailed walking directions from your parking spot to your destination. A map with a location pin also shows where you last parked once you're ready to head back to your car.



■ **Estimated time of arrival** provides you with detailed updates of your regular routes and alternative options so you can manage your journey and avoid delays.



■ With **Learned destinations** BMW Connected learns your most frequently travelled routes and provides them as future suggestions. If destinations are repeatedly visited, they are automatically listed at the usual time.



■ **Remote Services** enables you to use a smartphone to locate where your BMW is parked, to lock and unlock the car remotely and much more.



□ **Time to leave** function provides notifications on your Apple iPhone®, compatible Android phone, your Apple Watch® or Samsung Gear S3® watch, and recommends a time to leave to help you arrive on time.



■ **Apple CarPlay® preparation** enables wireless and comfortable usage of your iPhone® in your vehicle via Apple CarPlay®. Selected smartphone content can be displayed and operated via the user interface of the vehicle.

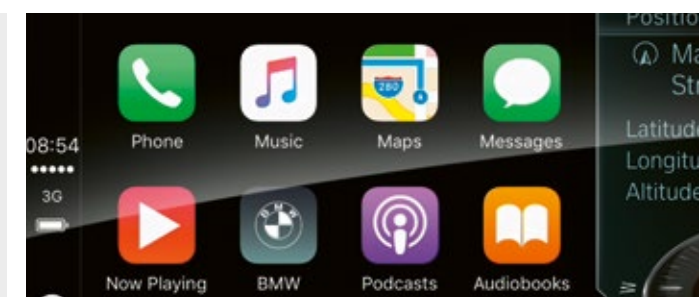

■ **BMW Emergency Call** automatically establishes a voice connection with the local emergency services without the use of a mobile phone. It transmits information about the vehicle's current location and can be triggered manually in case other road users require help.



■ **BMW Online Services** forms the basis for using the BMW ConnectedDrive functions. In addition, selected smartphone apps can be used in the vehicle, alongside the BMW ConnectedDrive Store.

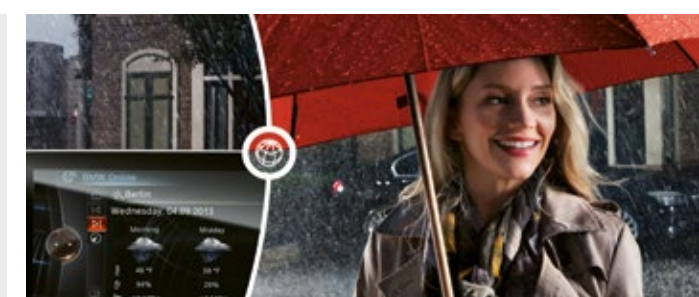

■ **BMW TeleServices** transmits vehicle service data to BMW and supports the processing of servicing appointments. In the event of a breakdown, help can be requested from a BMW Centre allowing some malfunctions to be resolved remotely.

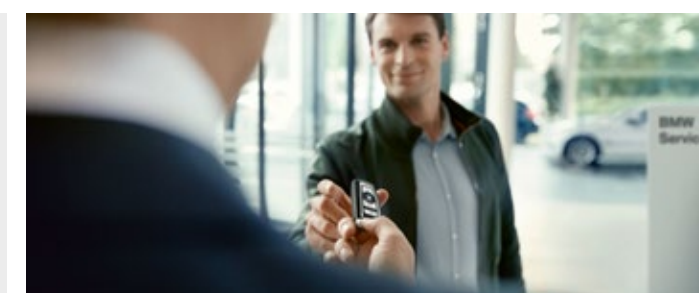

■ **Real Time Traffic Information (RTTI)** collects current traffic information about motorways, main and country roads and urban routes. It relays information about delays and dangers and suggests the best alternative routes.



MY BMW APP.

The My BMW App is the direct connection inside and outside your BMW. Plan your next trip, check the status of your vehicle or use one of the remote service functions – all conveniently from your smartphone.

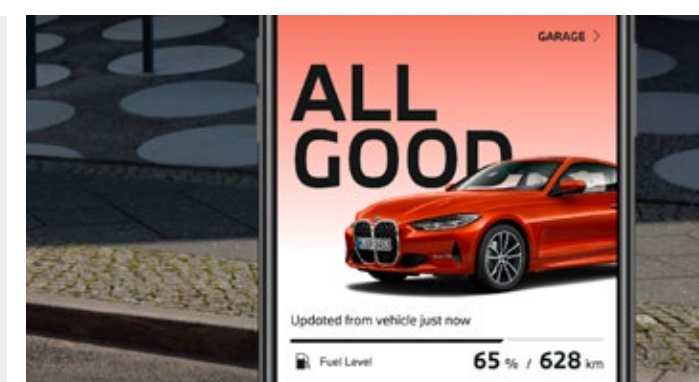

WHEELS & TYRES.

19" LIGHT ALLOY M DOUBLE-SPOKE STYLE 816 M WHEELS, BICOLOUR.

19" light alloy M Double-spoke style 816 M wheels, Bicolour, 8 J x 19 with 225/45 R19 tyres.

Optionally available on M Sport models. Exclusively available with M Sport Pro Pack, excluding xDrive25e.



18" LIGHT ALLOY Y-SPOKE STYLE 579 WHEELS, BICOLOUR.

18" light alloy Y-spoke style 579 wheels, Bicolour, 7.5 J x 18 with 225/50 R18 tyres.

Standard for xLine models.



18" LIGHT ALLOY Y-SPOKE STYLE 566 WHEELS.

18" light alloy Y-spoke style 566 wheels, 7.5 J x 18 with 225/50 R18 tyres.

Optionally available on xLine models.

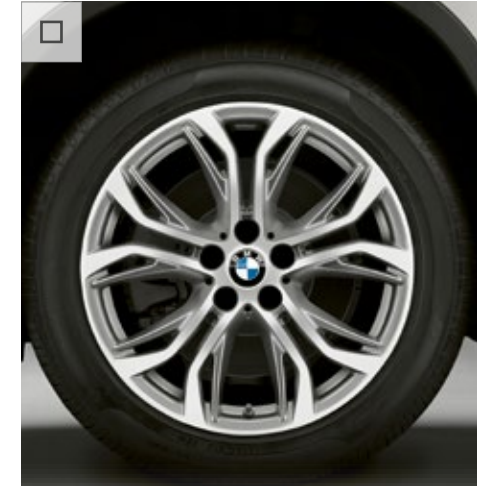

19" LIGHT ALLOY Y-SPOKE STYLE 580 WHEELS, BICOLOUR.

19" light alloy Y-spoke style 580 wheels, Bicolour, 8 J x 19 with 225/45 R19 tyres.

Optionally available on xLine models.



18" LIGHT ALLOY DOUBLE-SPOKE STYLE 578 WHEELS, JET BLACK.

18" light alloy Double-spoke style 578 wheels, Jet Black, 7.5 J x 18 with 225/50 R18 tyres.

Standard on Sport models.

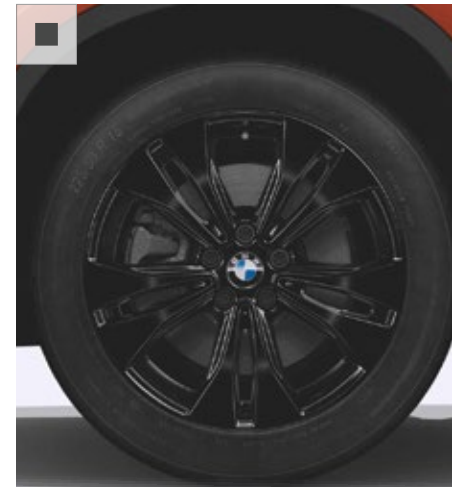

17" LIGHT ALLOY DOUBLE-SPOKE STYLE 564 WHEELS.

17" light alloy Double-spoke style 564 wheels, 7.5 J x 17 with 225/55 R17 tyres.

Optionally available on SE models.

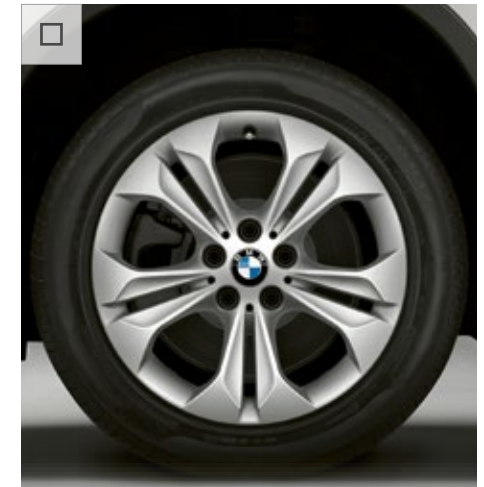

19" LIGHT ALLOY Y-SPOKE STYLE 511 WHEELS.

19" light alloy Y-spoke style 511 wheels, 8 J x 19 with 225/45 R19 tyres.

Optionally available on Sport models.



18" M LIGHT ALLOY DOUBLE-SPOKE STYLE 570 M WHEELS.

18" M light alloy Double-spoke style 570 M wheels, Bicolour, 7.5 J x 18 with 225/50 R18 tyres.

Standard on M Sport models.



17" LIGHT ALLOY V-SPOKE STYLE 560 WHEELS.

17" light alloy V-spoke style 560 wheels, 7.5 J x 17 with 225/55 R17 tyres.

Standard on SE models.



GENUINE BMW ACCESSORIES.



ROOF BOX.

This contemporary roof box in Black with titanium silver side trims has a 520-litre capacity and fits all BMW roof rack systems. It can be opened from both sides and features triple central locking on each side which makes it easy to load and provides anti-theft locking. Roof boxes in other sizes are also available. Roof rails required for use.



UNIVERSAL HOLDER FOR TABLETS.

The universal holder is adjustable in terms of size and it is snapped into position into the basic carrier of the Travel & Comfort System that is available separately. It provides a secure hold for a wide range of Apple and Samsung tablets from 7" to 11" with Travel & Comfort tablet safety case. It can be rotated through 360°, tilted and fixed in the desired position.

20" M LIGHT ALLOY DOUBLE-SPOKE STYLE 717 M WHEELS.

The high-quality 20" M light alloy Double-spoke 717 M wheels are designed in matt Jet Black, weight-optimised with flow forming and with M logo. TPMS summer complete wheel set with run-flat tyres, wheel size 8J x 20 with tyre size 225/40 R20 94Y RSC.



LUGGAGE COMPARTMENT MAT.

Anti-slip, water-resistant mat for protecting the luggage compartment from dirt and moisture. In Black with stainless steel inlay matching the interior.



ADVANCED CAR EYE 2.0.

The highly sensitive full-HD Advanced Car Eye 2.0 records automatically in order to capture events as seen from the vehicle, even when it is parked.



FLOATING HUB CAP.

The Floating Hub Cap consists of the BMW logo that does not turn with the wheel but instead remains level.



ALL-WEATHER FLOOR MATS.

Precisely fitting protection against moisture and dirt in the front footwell. Featuring a Black design, they perfectly complement the interior.

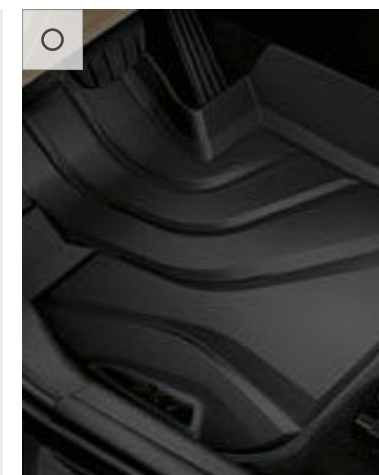

PRICING INFORMATION.

PETROL & PLUG-IN HYBRID ELECTRIC VEHICLES



	sDrive18i SE	sDrive18i Sport	sDrive18i xLine	sDrive18i M Sport	sDrive20i SE	sDrive20i Sport	sDrive20i xLine	sDrive20i M Sport	xDrive20i SE	xDrive20i Sport	xDrive20i xLine	xDrive20i M Sport	xDrive25e Sport	xDrive25e xLine	xDrive25e M Sport
--	--------------	-----------------	-----------------	-------------------	--------------	-----------------	-----------------	-------------------	--------------	-----------------	-----------------	-------------------	-----------------	-----------------	-------------------

Basic price (excluding VAT)	£23,612.50	£25,070.83	£25,904.17	£26,570.83	£26,304.17	£27,762.50	£28,595.83	£29,262.50	£27,554.17	£29,012.50	£29,845.83	£30,512.50	£31,079.17	£31,912.50	£32,579.17
VAT 20%	£4,722.50	£5,014.17	£5,180.83	£5,314.17	£5,260.83	£5,552.50	£5,719.17	£5,852.50	£5,510.83	£5,802.50	£5,969.17	£6,102.50	£6,215.83	£6,382.50	£6,515.83
RRP (including VAT)	£28,335	£30,085	£31,085	£31,885	£31,565	£33,315	£34,315	£35,115	£33,065	£34,815	£35,815	£36,615	£37,295	£38,295	£39,095
On the road price from	£29,455	£31,205	£32,205	£33,005	£32,685	£34,435	£35,435	£36,235	£34,510	£36,260	£37,260	£38,060	£38,200	£39,200	£40,000
P11d value – Manual	£29,185	£30,935	£31,935	£32,735	-	-	-	-	-	-	-	-	-	-	-
P11d value – Automatic	£30,535	£32,285	£33,285	£34,085	£32,415	£34,165	£35,165	£35,965	£33,915	£35,665	£36,665	£37,465	£38,145	£39,145	£39,945
BIK tax rate (2020 / 2021)	32%-31% (32%)	32%-31% (33%-32%)	32%-31% (33%-32%)	32%-31% (33%-32%)	(33%-32%)	(33%-32%)	(34%-33%)	(34%-33%)	(35%-34%)	(35%)	(36%-35%)	(36%-35%)	(10%)	(10%)	(10%)
Insurance group	22	22	22	22	28	28	29	29	29	29	29	30	30	30	30
RDE2 Compliant (Y / N)	Y	Y	Y	Y	Y	Y	Y	Y	Y	Y	Y	Y	Y	Y	Y

PRICES AND SPECIFICATIONS

BMW (UK) Limited reserves the right to alter prices and specifications without notice. BMW (UK) Limited has made every effort to ensure the accuracy of information but does not accept liability for any errors or omissions.

VED RATES

Annual VED (second year onwards), for cars costing over £40,000, is payable for five years. VED rates for brand new cars are determined by their CO₂ emissions figure. First year VED applies to the first year of ownership. Annual VED rates apply thereafter. The BMW X1 models fall into one of the categories listed below:

CO ₂ emissions (g/km)	01-50	51-75	76-90	91-100	101-110	111-130	131-150	151-170	171-190	191-225	226-255	Over 255
First year VED (petrol and RDE2 diesel)	£10	£25	£110	£135	£155	£175	£215	£540	£870	£1,305	£1,850	£2,175
First year VED (alternative fuel vehicles)	£0	£15	£100	£125	£145	£165	£205	£530	£860	£1,295	£1,840	£2,165
Annual VED – second year onwards (standard rate for petrol and diesel)	£150	£150	£150	£150	£150	£150	£150	£150	£150	£150	£150	£150
Annual VED – second year onwards (alternative fuel vehicles over £40,000)	£465	£465	£465	£465	£465	£465	£465	£465	£465	£465	£465	£465
Annual VED – second year onwards (petrol and diesel cars over £40,000)	£475	£475	£475	£475	£475	£475	£475	£475	£475	£475	£475	£475

ON THE ROAD PRICE

The recommended on the road price includes:

Delivery and BMW Emergency Service	£825
Number plates	£25
Vehicle first registration fee	£55
First year Vehicle Excise Duty	See left

Figures in () apply to cars with automatic transmission. Insurance group figures refer to 50 Group Rating System. For Plug-in Hybrid Electric Vehicles these figures were obtained using a combination of battery power and fuel. Plug-in Hybrid Electric Vehicles require mains electricity for charging. Figures shown are for comparability purposes. Only compare fuel consumption, CO₂ and electric range figures with other cars tested to the same technical procedures. These figures may not reflect real life driving results, which will depend upon a number of factors including the starting charge of the battery, accessories fitted (post-registration), variations in weather, driving styles and vehicle load. The CO₂ figures have been determined according to the WLTP test. WLTP has been used as the applicable CO₂ figure from 1 April 2020 for first year vehicle tax (VED) and from 6 April 2020 for company car tax (BIK). The CO₂ figures were previously based on the NEDC equivalent.

PRICING INFORMATION.

DIESEL



sDrive18d SE	sDrive18d Sport	sDrive18d xLine	sDrive18d M Sport	xDrive18d SE	xDrive18d Sport	xDrive18d xLine	xDrive18d M Sport	xDrive20d SE	xDrive20d Sport	xDrive20d xLine	xDrive20d M Sport
--------------	-----------------	-----------------	-------------------	--------------	-----------------	-----------------	-------------------	--------------	-----------------	-----------------	-------------------

Basic price (excluding VAT)	£25,087.50	£26,545.83	£27,379.17	£28,045.83	£26,337.50	£27,795.83	£28,629.17	£29,295.83	£28,504.17	£29,962.50	£30,795.83	£31,462.50
VAT 20%	£5,017.50	£5,309.17	£5,475.83	£5,609.17	£5,267.50	£5,559.17	£5,725.83	£5,859.17	£5,700.83	£5,992.50	£6,159.17	£6,292.50
RRP (including VAT)	£30,105	£31,855	£32,855	£33,655	£31,605	£33,355	£34,355	£35,155	£34,205	£35,955	£36,955	£37,755
On the road price from	£31,225	£32,975	£33,975	£34,775	£32,725	£34,475	£35,475	£36,275	£35,325	£37,075	£38,075	£38,875
P11d value – Manual	£30,955	£32,705	£33,705	£34,505	£32,455	£34,205	£35,205	£36,005	-	-	-	-
P11d value – Automatic	£32,555	£34,305	£35,305	£36,105	£34,055	£35,805	£36,805	£37,605	£35,055	£36,805	£37,805	£38,605
BIK tax rate (2020 / 2021)	30%-29% (31%)	30%-29% (32%-31%)	30%-29% (32%-31%)	30% (32%-31%)	32% (33%-32%)	33%-32% (33%-32%)	33%-32% (33%-32%)	33%-32% (33%-32%)	(33%-32%)	(33%-32%)	(33%)	(33%)
Insurance group	23	23	24	24	23	23	24	24	28	29	29	29
RDE2 Compliant (Y / N)	Y	Y	Y	Y	Y	Y	Y	Y	Y	Y	Y	Y

PRICES AND SPECIFICATIONS

BMW (UK) Limited reserves the right to alter prices and specifications without notice. BMW (UK) Limited has made every effort to ensure the accuracy of information but does not accept liability for any errors or omissions.

VED RATES

Annual VED (second year onwards), for cars costing over £40,000, is payable for five years. VED rates for brand new cars are determined by their CO₂ emissions figure. First year VED applies to the first year of ownership. Annual VED rates apply thereafter. The BMW X1 models fall into one of the categories listed below:

CO ₂ emissions (g/km)	01-50	51-75	76-90	91-100	101-110	111-130	131-150	151-170	171-190	191-225	226-255	Over 255
First year VED (petrol and RDE2 diesel)	£10	£25	£110	£135	£155	£175	£215	£540	£870	£1,305	£1,850	£2,175
Annual VED – second year onwards (standard rate for petrol and diesel)	£150	£150	£150	£150	£150	£150	£150	£150	£150	£150	£150	£150
Annual VED – second year onwards (petrol and diesel cars over £40,000)	£475	£475	£475	£475	£475	£475	£475	£475	£475	£475	£475	£475

ON THE ROAD PRICE

The recommended on the road price includes:

Delivery and BMW Emergency Service	£825
Number plates	£25
Vehicle first registration fee	£55
First year Vehicle Excise Duty	See left

Figures in () apply to cars with automatic transmission. Insurance group figures refer to 50 Group Rating System. For Plug-in Hybrid Electric Vehicles these figures were obtained using a combination of battery power and fuel. Plug-in Hybrid Electric Vehicles require mains electricity for charging. Figures shown are for comparability purposes. Only compare fuel consumption, CO₂ and electric range figures with other cars tested to the same technical procedures. These figures may not reflect real life driving results, which will depend upon a number of factors including the starting charge of the battery, accessories fitted (post-registration), variations in weather, driving styles and vehicle load. The CO₂ figures have been determined according to the WLTP test. WLTP has been used as the applicable CO₂ figure from 1 April 2020 for first year vehicle tax (VED) and from 6 April 2020 for company car tax (BIK). The CO₂ figures were previously based on the NEDC equivalent.

TECHNICAL INFORMATION.

PETROL & PLUG-IN HYBRID ELECTRIC VEHICLES



sDrive18i SE	sDrive18i Sport	sDrive18i xLine	sDrive18i M Sport	sDrive20i SE	sDrive20i Sport	sDrive20i xLine	sDrive20i M Sport	xDrive20i SE	xDrive20i Sport	xDrive20i xLine	xDrive20i M Sport	xDrive25e Sport	xDrive25e xLine	xDrive25e M Sport
--------------	-----------------	-----------------	-------------------	--------------	-----------------	-----------------	-------------------	--------------	-----------------	-----------------	-------------------	-----------------	-----------------	-------------------

Power output (hp)	136	136	136	136	178	178	178	178	178	178	178	220^	220^	220^	
0-62mph / 0-100km/h (secs)	9.7 (9.7)	9.7 (9.7)	9.7 (9.7)	9.7 (9.7)	(7.6)	(7.6)	(7.6)	(7.6)	(7.3)	(7.3)	(7.3)	(7.3)	(6.9)	(6.9)	(6.9)
Fuel consumption - combined (mpg)*	44.1-45.6 (42.8-44.1)	44.1-45.6 (42.8-44.1)	43.5-44.8 (42.8-44.1)	43.5-44.8 (42.2-43.5)	(42.2-43.5)	(41.5-42.8)	(41.5-42.8)	(41.5-42.8)	(39.8-40.4)	(39.2-40.4)	(39.2-40.4)	(38.7-40.4)	(148.7-156.9)**	(148.7-156.9)**	(148.7-156.9)**
Fuel consumption - combined (l/100km)*	6.4-6.2 (6.6-6.4)	6.4-6.2 (6.6-6.4)	6.5-6.3 (6.6-6.4)	6.5-6.3 (6.7-6.5)	(6.7-6.5)	(6.8-6.6)	(6.8-6.6)	(6.8-6.6)	(7.1-7.0)	(7.2-7.0)	(7.2-7.0)	(7.3-7.0)	(1.9-1.8)**	(1.9-1.8)**	(1.9-1.8)**
CO ₂ emissions - combined (g/km)*	145-141 (149-145)	146-141 (150-146)	147-142 (151-146)	148-143 (152-147)	(153-149)	(154-149)	(155-150)	(156-150)	(163-159)	(164-160)	(165-160)	(165-160)	(43-40)**	(43-41)**	(44-41)**
Electric energy consumption - weighted combined (miles/kWh)*	-	-	-	-	-	-	-	-	-	-	-	-	(4.1)	(4.1)	(4.0-4.1)
Electric energy consumption - weighted combined (km/kWh)*	-	-	-	-	-	-	-	-	-	-	-	-	(15.3-15.1)	(15.3-15.1)	(15.4-15.2)
Equivalent all-electric range (miles)*	-	-	-	-	-	-	-	-	-	-	-	-	(31.1-32.3)	(31.1-31.7)	(30.4-31.7)
Equivalent all electric range (km)*	-	-	-	-	-	-	-	-	-	-	-	-	(50.0-52.0)	(50.0-51.0)	(49.0-51.0)

* = For Plug-in Hybrid Electric Vehicles these figures were obtained using a combination of battery power and fuel. Plug-in Hybrid Electric Vehicles require mains electricity for charging. Figures shown are for comparability purposes. Only compare fuel consumption, CO₂ and electric range figures with other cars tested to the same technical procedures. These figures may not reflect real life driving results, which will depend upon a number of factors including the starting charge of the battery, accessories fitted (post-registration), variations in weather, driving styles and vehicle load. The CO₂ figures shown above have been determined according to the WLTP test. WLTP has been used as the applicable CO₂ figure from 1 April 2020 for first year vehicle tax (VED) and from 6 April 2020 for company car tax (BIK). The CO₂ figures were previously based on the NEDC equivalent. ** = Figures are weighted combined. ^ = Combined power from Petrol and Electric engines. Figures in () apply to cars with automatic transmission.

TECHNICAL INFORMATION.

DIESEL



sDrive18d SE	sDrive18d Sport	sDrive18d xLine	sDrive18d M Sport	xDrive18d SE	xDrive18d Sport	xDrive18d xLine	xDrive18d M Sport	xDrive20d SE	xDrive20d Sport	xDrive20d xLine	xDrive20d M Sport
--------------	-----------------	-----------------	-------------------	--------------	-----------------	-----------------	-------------------	--------------	-----------------	-----------------	-------------------

Power output (hp)	150	150	150	150	150	150	150	190	190	190	190	
0-62mph / 0-100km/h (secs)	9.3 (9.4)	9.3 (9.4)	9.3 (9.4)	9.3 (9.4)	9.3 (9.4)	9.3 (9.4)	9.3 (9.4)	(7.8)	(7.8)	(7.8)	(7.8)	
Fuel consumption - combined (mpg)*	54.3-55.4 (51.4-52.3)	53.3-55.4 (51.4-52.3)	53.3-55.4 (50.4-52.3)	53.3-54.3 (50.4-52.3)	49.6-50.4 (48.7-50.4)	49.6-50.4 (48.7-50.4)	49.6-50.4 (48.7-49.6)	48.7-50.4 (47.9-49.6)	(48.7-49.6)	(48.7-49.6)	(47.9-49.6)	(47.9-49.6)
Fuel consumption - combined (l/100km)*	5.2-5.1 (5.5-5.4)	5.3-5.1 (5.5-5.4)	5.3-5.1 (5.6-5.4)	5.3-5.2 (5.6-5.4)	5.7-5.6 (5.8-5.6)	5.7-5.6 (5.8-5.6)	5.7-5.6 (5.8-5.7)	5.8-5.6 (5.9-5.7)	(5.8-5.7)	(5.8-5.7)	(5.9-5.7)	(5.9-5.7)
CO ₂ emissions - combined (g/km)*	137-133 (144-140)	138-134 (145-141)	138-134 (146-142)	139-135 (146-142)	149-145 (151-147)	150-146 (152-148)	151-147 (153-149)	151-147 (153-149)	(152-149)	(153-149)	(154-150)	(154-150)

* = For Plug-in Hybrid Electric Vehicles these figures were obtained using a combination of battery power and fuel. Plug-in Hybrid Electric Vehicles require mains electricity for charging. Figures shown are for comparability purposes. Only compare fuel consumption, CO₂ and electric range figures with other cars tested to the same technical procedures. These figures may not reflect real life driving results, which will depend upon a number of factors including the starting charge of the battery, accessories fitted (post-registration), variations in weather, driving styles and vehicle load. The CO₂ figures shown above have been determined according to the WLTP test. WLTP has been used as the applicable CO₂ figure from 1 April 2020 for first year vehicle tax (VED) and from 6 April 2020 for company car tax (BIK). The CO₂ figures were previously based on the NEDC equivalent. ^ = Combined power from Petrol and Electric engines. Figures in () apply to cars with automatic transmission.

OPTIONAL EQUIPMENT PRICING.



	sDrive18i SE	sDrive18i Sport	sDrive18i xLine	sDrive18i M Sport	sDrive20i SE	sDrive20i Sport	sDrive20i xLine	sDrive20i M Sport	xDrive20i SE	xDrive20i Sport	xDrive20i xLine	xDrive20i M Sport	xDrive25e Sport	xDrive25e xLine	xDrive25e M Sport	sDrive18d SE	sDrive18d Sport	sDrive18d xLine	sDrive18d M Sport	xDrive18d SE	xDrive18d Sport	xDrive18d xLine	xDrive18d M Sport	xDrive20d SE	xDrive20d Sport	xDrive20d xLine	xDrive20d M Sport	Price
--	--------------	-----------------	-----------------	-------------------	--------------	-----------------	-----------------	-------------------	--------------	-----------------	-----------------	-------------------	-----------------	-----------------	-------------------	--------------	-----------------	-----------------	-------------------	--------------	-----------------	-----------------	-------------------	--------------	-----------------	-----------------	-------------------	-------

PAINTWORK

Non-metallic Available in Alpine White or Jet Black ¹	■	■	■	■	■	■	■	■	■	■	■	■	■	■	■	■	■	■	■	■	■	■	■	■	■	■	Std
Metallic Available in Black Sapphire, Cashmere Silver ¹ , Glacier Silver ¹ , Mineral Grey, Mineral White, Misano Blue ² , Phytonic Blue ¹ , Sparkling Brown ¹ or Sunset Orange ¹	□	□	□	□	□	□	□	□	□	□	□	□	□	□	□	□	□	□	□	□	□	□	□	□	□	□	£560
BMW Individual Available in Storm Bay metallic	-	-	□	□	-	-	□	□	-	-	□	□	-	□	□	-	-	□	□	-	-	□	□	-	-	□	£560

UPHOLSTERY

Grid cloth Available in Anthracite	■	-	-	-	■	-	-	-	■	-	-	-	-	-	-	■	-	-	-	■	-	-	-	-	-	-	Std
Nivala cloth / Sensatec Available in Anthracite with Grey highlight or Anthracite with Orange highlight	-	■	-	-	-	■	-	-	-	■	-	-	■	-	-	-	■	-	-	-	■	-	-	-	-	-	Std
Dakota leather ³ – SE models Available in Black	□	-	-	-	□	-	-	-	□	-	-	-	-	-	-	□	-	-	-	□	-	-	-	□	-	-	£1,150
– Sport models Available in Black with Grey stitching, Mocha with contrast stitching or Oyster with Grey highlight and stitching	-	□	-	-	-	□	-	-	-	□	-	-	□	-	-	-	□	-	-	-	□	-	-	-	□	-	£1,150
– xLine models Available in Black with Grey stitching, Mocha with contrast stitching or Oyster with Grey highlight and stitching	-	-	■	-	-	-	■	-	-	-	■	-	-	■	-	-	-	■	-	-	-	■	-	-	■	-	Std
– M Sport models Available in Black with Blue stitching, Black with Grey stitching, Mocha with contrast stitching or Oyster with Grey highlight and stitching	-	-	-	■	-	-	-	■	-	-	-	■	-	-	■	-	-	-	■	-	-	-	■	-	-	■	Std



	sDrive18i SE	sDrive18i Sport	sDrive18i xLine	sDrive18i M Sport	sDrive20i SE	sDrive20i Sport	sDrive20i xLine	sDrive20i M Sport	xDrive20i SE	xDrive20i Sport	xDrive20i xLine	xDrive20i M Sport	xDrive25e Sport	xDrive25e xLine	xDrive25e M Sport	sDrive18d SE	sDrive18d Sport	sDrive18d xLine	sDrive18d M Sport	xDrive18d SE	xDrive18d Sport	xDrive18d xLine	xDrive18d M Sport	xDrive20d SE	xDrive20d Sport	xDrive20d xLine	xDrive20d M Sport	Price
--	--------------	-----------------	-----------------	-------------------	--------------	-----------------	-----------------	-------------------	--------------	-----------------	-----------------	-------------------	-----------------	-----------------	-------------------	--------------	-----------------	-----------------	-------------------	--------------	-----------------	-----------------	-------------------	--------------	-----------------	-----------------	-------------------	-------

INTERIOR TRIMS

Aluminium Hexagon with Estoril Blue finisher	-	-	-	■	-	-	-	■	-	-	-	■	-	-	■	-	-	-	■	-	-	-	■	-	-	-	■	Std
Brushed Aluminium with Pearl Chrome finisher	-	□	□	-	-	□	□	-	-	□	□	-	□	□	-	-	□	□	-	-	□	□	-	□	□	-	-	£110
Fine Oak matt wood with Pearl Chrome finisher	-	-	-	□	-	-	-	□	-	-	-	□	-	-	□	-	-	-	□	-	-	-	□	-	-	-	-	£0
Fineline Stream wood with Pearl Chrome finisher	-	□	□	-	-	□	□	-	-	□	□	-	□	□	-	-	□	□	-	-	□	□	-	□	□	-	-	£230
High-gloss Black with Pearl Chrome finisher	-	■	■	□	-	■	■	□	-	■	■	□	■	■	□	-	■	■	□	-	■	■	□	-	■	■	□	£120
Oxide Silver with Black, High-gloss finisher	■	-	-	-	■	-	-	-	■	-	-	-	-	-	-	■	-	-	-	■	-	-	-	■	-	-	-	Std

TRANSMISSIONS

Automatic transmission	-	-	-	-	-	-	-	-	-	-	-	-	■	■	■	-	-	-	-	-	-	-	-	-	-	-	-	Std
Dual-clutch automatic transmission	□	□	□	□	-	-	-	-	-	-	-	-	-	-	-	-	-	-	-	-	-	-	-	-	-	-	-	£1,350
Sport automatic transmission	-	-	-	-	-	-	-	-	■	■	■	■	-	-	-	□	□	□	□	□	□	□	□	■	■	■	■	£1,600
Sport Dual-clutch automatic transmission	-	-	-	-	■	■	■	■	-	-	-	-	-	-	-	-	-	-	-	-	-	-	-	-	-	-	-	Std

BMW EFFICIENT DYNAMICS

Auto Start-Stop	■	■	■	■	■	■	■	■	■	■	■	■	■	■	■	■	■	■	■	■	■	■	■	■	■	■	■	Std
Brake Energy Regeneration	■	■	■	■	■	■	■	■	■	■	■	■	■	■	■	■	■	■	■	■	■	■	■	■	■	■	■	Std
ECO PRO mode	■	■	■	■	■	■	■	■	■	■	■	■	■	■	■	■	■	■	■	■	■	■	■	■	■	■	■	Std
Lightweight Engineering	■	■	■	■	■	■	■	■	■	■	■	■	■	■	■	■	■	■	■	■	■	■	■	■	■	■	■	Std
Optimum Shift Indicator	■	■	■	■	-	-	-	-	-	-	-	-	-	-	-	■	■	■	■	■	■	■	■	-	-	-	-	Std

Individual BMW EfficientDynamics features may be excluded, depending on the optional equipment chosen. Your BMW Centre will be pleased to provide you with more information.



sDrive18i SE	sDrive18i Sport	sDrive18i xLine	sDrive18i M Sport	sDrive20i SE	sDrive20i Sport	sDrive20i xLine	sDrive20i M Sport	xDrive20i SE	xDrive20i Sport	xDrive20i xLine	xDrive20i M Sport	xDrive25e Sport	xDrive25e xLine	xDrive25e M Sport	sDrive18d SE	sDrive18d Sport	sDrive18d xLine	sDrive18d M Sport	xDrive18d SE	xDrive18d Sport	xDrive18d xLine	xDrive18d M Sport	xDrive20d SE	xDrive20d Sport	xDrive20d xLine	xDrive20d M Sport	Price
--------------	-----------------	-----------------	-------------------	--------------	-----------------	-----------------	-------------------	--------------	-----------------	-----------------	-------------------	-----------------	-----------------	-------------------	--------------	-----------------	-----------------	-------------------	--------------	-----------------	-----------------	-------------------	--------------	-----------------	-----------------	-------------------	-------

PACKAGES

Packages provide an intelligent selection of individual options at a lower combined price, as well as contributing to the resale value of the vehicle. Further options can still be specified even when a package is chosen.

COMFORT PACK I Comprises: – Extended lighting – Exterior mirrors – electrically-folding with anti-dazzle – Seat heating, front	<input type="checkbox"/>	<input type="checkbox"/>	-	-	<input type="checkbox"/>	<input type="checkbox"/>	-	-	<input type="checkbox"/>	<input type="checkbox"/>	-	-	<input type="checkbox"/>	-	-	<input type="checkbox"/>	<input type="checkbox"/>	-	-	<input type="checkbox"/>	<input type="checkbox"/>	-	-	<input type="checkbox"/>	<input type="checkbox"/>	£850
COMFORT PACK II Comprises: – Comfort Access – Seat adjustment – front, electric with driver memory – Steering wheel heating	<input type="checkbox"/>	<input type="checkbox"/>	<input type="checkbox"/>	<input type="checkbox"/>	<input type="checkbox"/>	<input type="checkbox"/>	<input type="checkbox"/>	<input type="checkbox"/>	<input type="checkbox"/>	<input type="checkbox"/>	<input type="checkbox"/>	<input type="checkbox"/>	<input type="checkbox"/>	<input type="checkbox"/>	<input type="checkbox"/>	<input type="checkbox"/>	<input type="checkbox"/>	<input type="checkbox"/>	<input type="checkbox"/>	<input type="checkbox"/>	<input type="checkbox"/>	<input type="checkbox"/>	<input type="checkbox"/>	<input type="checkbox"/>	<input type="checkbox"/>	£1,000
M SPORT PRO PACK Comprises: – 19" M Double-spoke style 816 M wheels, Bicolour – BMW Individual High-gloss Shadowline with extended contents – Loudspeaker system – harman/kardon – M seat belts – M Sport braking system ¹ – M Sport steering – Sun protection glass	-	-	-	<input type="checkbox"/>	-	-	-	<input type="checkbox"/>	-	-	-	<input type="checkbox"/>	-	-	-	<input type="checkbox"/>	-	-	-	-	<input type="checkbox"/>	-	-	-	<input type="checkbox"/>	£2,350
TECHNOLOGY PACK I Comprises: – Adaptive LED headlights – Enhanced Bluetooth with wireless charging – Reversing Assist camera	<input type="checkbox"/>	<input type="checkbox"/>	<input type="checkbox"/>	<input type="checkbox"/>	<input type="checkbox"/>	<input type="checkbox"/>	<input type="checkbox"/>	<input type="checkbox"/>	<input type="checkbox"/>	<input type="checkbox"/>	<input type="checkbox"/>	<input type="checkbox"/>	<input type="checkbox"/>	<input type="checkbox"/>	<input type="checkbox"/>	<input type="checkbox"/>	<input type="checkbox"/>	<input type="checkbox"/>	<input type="checkbox"/>	<input type="checkbox"/>	<input type="checkbox"/>	<input type="checkbox"/>	<input type="checkbox"/>	<input type="checkbox"/>	<input type="checkbox"/>	£900
TECHNOLOGY PACK II Comprises: – BMW Navigation Plus – Head-up Display	<input type="checkbox"/>	<input type="checkbox"/>	<input type="checkbox"/>	<input type="checkbox"/>	<input type="checkbox"/>	<input type="checkbox"/>	<input type="checkbox"/>	<input type="checkbox"/>	<input type="checkbox"/>	<input type="checkbox"/>	<input type="checkbox"/>	<input type="checkbox"/>	<input type="checkbox"/>	<input type="checkbox"/>	<input type="checkbox"/>	<input type="checkbox"/>	<input type="checkbox"/>	<input type="checkbox"/>	<input type="checkbox"/>	<input type="checkbox"/>	<input type="checkbox"/>	<input type="checkbox"/>	<input type="checkbox"/>	<input type="checkbox"/>	<input type="checkbox"/>	£1,250

¹ = Not with Space saver space wheel.



	sDrive18i SE	sDrive18i Sport	sDrive18i xLine	sDrive18i M Sport	sDrive20i SE	sDrive20i Sport	sDrive20i xLine	sDrive20i M Sport	xDrive20i SE	xDrive20i Sport	xDrive20i xLine	xDrive20i M Sport	xDrive25e Sport	xDrive25e xLine	xDrive25e M Sport	sDrive18d SE	sDrive18d Sport	sDrive18d xLine	sDrive18d M Sport	xDrive18d SE	xDrive18d Sport	xDrive18d xLine	xDrive18d M Sport	xDrive20d SE	xDrive20d Sport	xDrive20d xLine	xDrive20d M Sport	Price
--	--------------	-----------------	-----------------	-------------------	--------------	-----------------	-----------------	-------------------	--------------	-----------------	-----------------	-------------------	-----------------	-----------------	-------------------	--------------	-----------------	-----------------	-------------------	--------------	-----------------	-----------------	-------------------	--------------	-----------------	-----------------	-------------------	-------

SAFETY & TECHNOLOGY.

Active Cruise Control with Stop&Go function Only with Driving Assistant Plus + Sport automatic transmission	<input type="checkbox"/>	<input type="checkbox"/>	<input type="checkbox"/>	<input type="checkbox"/>	<input type="checkbox"/>	<input type="checkbox"/>	<input type="checkbox"/>	<input type="checkbox"/>	<input type="checkbox"/>	<input type="checkbox"/>	<input type="checkbox"/>	<input type="checkbox"/>	<input type="checkbox"/>	<input type="checkbox"/>	<input type="checkbox"/>	<input type="checkbox"/>	<input type="checkbox"/>	<input type="checkbox"/>	<input type="checkbox"/>	<input type="checkbox"/>	<input type="checkbox"/>	<input type="checkbox"/>	<input type="checkbox"/>	<input type="checkbox"/>	<input type="checkbox"/>	<input type="checkbox"/>	n/a
Driving Assistant Plus Comprises: – Active Cruise Control with Stop&Go function – Front Collision Warning – High-beam Assistant – Lane Departure Warning – Speed Limit Information – Traffic Jam Assist Only with Automatic transmission	<input type="checkbox"/>	<input type="checkbox"/>	<input type="checkbox"/>	<input type="checkbox"/>	<input type="checkbox"/>	<input type="checkbox"/>	<input type="checkbox"/>	<input type="checkbox"/>	<input type="checkbox"/>	<input type="checkbox"/>	<input type="checkbox"/>	<input type="checkbox"/>	<input type="checkbox"/>	<input type="checkbox"/>	<input type="checkbox"/>	<input type="checkbox"/>	<input type="checkbox"/>	<input type="checkbox"/>	<input type="checkbox"/>	<input type="checkbox"/>	<input type="checkbox"/>	<input type="checkbox"/>	<input type="checkbox"/>	<input type="checkbox"/>	<input type="checkbox"/>	<input type="checkbox"/>	£1,150
Larger fuel tank capacity Increased to 61 litres	<input type="checkbox"/>	<input type="checkbox"/>	<input type="checkbox"/>	<input type="checkbox"/>	-	-	-	-	<input checked="" type="checkbox"/>	<input checked="" type="checkbox"/>	<input checked="" type="checkbox"/>	<input checked="" type="checkbox"/>	-	-	-	<input type="checkbox"/>	<input type="checkbox"/>	<input type="checkbox"/>	<input type="checkbox"/>	<input type="checkbox"/>	<input type="checkbox"/>	<input type="checkbox"/>	<input type="checkbox"/>	<input type="checkbox"/>	<input type="checkbox"/>	<input type="checkbox"/>	£50
Lumbar support, front	<input type="checkbox"/>	<input type="checkbox"/>	<input type="checkbox"/>	<input type="checkbox"/>	<input type="checkbox"/>	<input type="checkbox"/>	<input type="checkbox"/>	<input type="checkbox"/>	<input type="checkbox"/>	<input type="checkbox"/>	<input type="checkbox"/>	<input type="checkbox"/>	<input type="checkbox"/>	<input type="checkbox"/>	<input type="checkbox"/>	<input type="checkbox"/>	<input type="checkbox"/>	<input type="checkbox"/>	<input type="checkbox"/>	<input type="checkbox"/>	<input type="checkbox"/>	<input type="checkbox"/>	<input type="checkbox"/>	<input type="checkbox"/>	<input type="checkbox"/>	<input type="checkbox"/>	£230
Space saver wheel with car jack Not with M Sport braking system	<input type="checkbox"/>	<input type="checkbox"/>	<input type="checkbox"/>	<input type="checkbox"/>	<input type="checkbox"/>	<input type="checkbox"/>	<input type="checkbox"/>	<input type="checkbox"/>	<input type="checkbox"/>	<input type="checkbox"/>	<input type="checkbox"/>	<input type="checkbox"/>	-	-	-	<input type="checkbox"/>	<input type="checkbox"/>	<input type="checkbox"/>	<input type="checkbox"/>	<input type="checkbox"/>	<input type="checkbox"/>	<input type="checkbox"/>	<input type="checkbox"/>	<input type="checkbox"/>	<input type="checkbox"/>	<input type="checkbox"/>	£150
Traffic Jam Assist Only with Driving Assistant Plus + Automatic transmission	<input type="checkbox"/>	<input type="checkbox"/>	<input type="checkbox"/>	<input type="checkbox"/>	<input type="checkbox"/>	<input type="checkbox"/>	<input type="checkbox"/>	<input type="checkbox"/>	<input type="checkbox"/>	<input type="checkbox"/>	<input type="checkbox"/>	<input type="checkbox"/>	<input type="checkbox"/>	<input type="checkbox"/>	<input type="checkbox"/>	<input type="checkbox"/>	<input type="checkbox"/>	<input type="checkbox"/>	<input type="checkbox"/>	<input type="checkbox"/>	<input type="checkbox"/>	<input type="checkbox"/>	<input type="checkbox"/>	<input type="checkbox"/>	<input type="checkbox"/>	<input type="checkbox"/>	n/a

EXTERIOR EQUIPMENT

Bike rack preparation Not with Towbar, detachable	<input type="checkbox"/>	<input type="checkbox"/>	<input type="checkbox"/>	<input type="checkbox"/>	<input type="checkbox"/>	<input type="checkbox"/>	<input type="checkbox"/>	<input type="checkbox"/>	<input type="checkbox"/>	<input type="checkbox"/>	<input type="checkbox"/>	<input type="checkbox"/>	<input type="checkbox"/>	<input type="checkbox"/>	<input type="checkbox"/>	<input type="checkbox"/>	<input type="checkbox"/>	<input type="checkbox"/>	<input type="checkbox"/>	<input type="checkbox"/>	<input type="checkbox"/>	<input type="checkbox"/>	<input type="checkbox"/>	<input type="checkbox"/>	<input type="checkbox"/>	<input type="checkbox"/>	£180
Exterior trim, Satin Aluminium	-	<input type="checkbox"/>	<input checked="" type="checkbox"/>	<input type="checkbox"/>	-	<input type="checkbox"/>	<input checked="" type="checkbox"/>	<input type="checkbox"/>	-	<input type="checkbox"/>	<input checked="" type="checkbox"/>	<input type="checkbox"/>	<input type="checkbox"/>	<input checked="" type="checkbox"/>	<input type="checkbox"/>	-	<input type="checkbox"/>	<input checked="" type="checkbox"/>	<input type="checkbox"/>	-	<input type="checkbox"/>	<input checked="" type="checkbox"/>	<input type="checkbox"/>	<input checked="" type="checkbox"/>	<input type="checkbox"/>	<input type="checkbox"/>	£0
Exterior trim, High-gloss Shadowline	-	<input checked="" type="checkbox"/>	<input type="checkbox"/>	<input checked="" type="checkbox"/>	-	<input checked="" type="checkbox"/>	<input type="checkbox"/>	<input checked="" type="checkbox"/>	-	<input checked="" type="checkbox"/>	<input type="checkbox"/>	<input checked="" type="checkbox"/>	<input checked="" type="checkbox"/>	<input type="checkbox"/>	<input checked="" type="checkbox"/>	-	<input checked="" type="checkbox"/>	<input type="checkbox"/>	<input checked="" type="checkbox"/>	-	<input checked="" type="checkbox"/>	<input type="checkbox"/>	<input checked="" type="checkbox"/>	<input type="checkbox"/>	<input checked="" type="checkbox"/>	<input type="checkbox"/>	£0
Exterior mirrors – electrically-folding with anti-dazzle Included within Comfort Pack I	<input type="checkbox"/>	<input type="checkbox"/>	<input checked="" type="checkbox"/>	<input checked="" type="checkbox"/>	<input type="checkbox"/>	<input type="checkbox"/>	<input checked="" type="checkbox"/>	<input checked="" type="checkbox"/>	<input type="checkbox"/>	<input type="checkbox"/>	<input checked="" type="checkbox"/>	<input checked="" type="checkbox"/>	<input type="checkbox"/>	<input checked="" type="checkbox"/>	<input type="checkbox"/>	<input type="checkbox"/>	<input type="checkbox"/>	<input checked="" type="checkbox"/>	<input checked="" type="checkbox"/>	<input type="checkbox"/>	<input type="checkbox"/>	<input checked="" type="checkbox"/>	<input checked="" type="checkbox"/>	<input type="checkbox"/>	<input type="checkbox"/>	<input type="checkbox"/>	n/a
Roof rails, High-gloss Shadowline	-	<input checked="" type="checkbox"/>	<input type="checkbox"/>	<input checked="" type="checkbox"/>	-	<input checked="" type="checkbox"/>	<input type="checkbox"/>	<input checked="" type="checkbox"/>	-	<input checked="" type="checkbox"/>	<input type="checkbox"/>	<input checked="" type="checkbox"/>	<input checked="" type="checkbox"/>	<input type="checkbox"/>	<input checked="" type="checkbox"/>	-	<input checked="" type="checkbox"/>	<input type="checkbox"/>	<input checked="" type="checkbox"/>	-	<input checked="" type="checkbox"/>	<input type="checkbox"/>	<input checked="" type="checkbox"/>	<input type="checkbox"/>	<input checked="" type="checkbox"/>	<input type="checkbox"/>	£0
Roof rails, Satin Aluminium	-	<input type="checkbox"/>	<input checked="" type="checkbox"/>	<input type="checkbox"/>	-	<input type="checkbox"/>	<input checked="" type="checkbox"/>	<input type="checkbox"/>	-	<input type="checkbox"/>	<input checked="" type="checkbox"/>	<input type="checkbox"/>	<input type="checkbox"/>	<input checked="" type="checkbox"/>	<input type="checkbox"/>	-	<input type="checkbox"/>	<input checked="" type="checkbox"/>	<input type="checkbox"/>	-	<input type="checkbox"/>	<input checked="" type="checkbox"/>	<input type="checkbox"/>	<input checked="" type="checkbox"/>	<input type="checkbox"/>	<input type="checkbox"/>	£0
Towbar, detachable Not with Bike rack preparation	<input type="checkbox"/>	<input type="checkbox"/>	<input type="checkbox"/>	<input type="checkbox"/>	<input type="checkbox"/>	<input type="checkbox"/>	<input type="checkbox"/>	<input type="checkbox"/>	<input type="checkbox"/>	<input type="checkbox"/>	<input type="checkbox"/>	<input type="checkbox"/>	<input type="checkbox"/>	<input type="checkbox"/>	<input type="checkbox"/>	<input type="checkbox"/>	<input type="checkbox"/>	<input type="checkbox"/>	<input type="checkbox"/>	<input type="checkbox"/>	<input type="checkbox"/>	<input type="checkbox"/>	<input type="checkbox"/>	<input type="checkbox"/>	<input type="checkbox"/>	<input type="checkbox"/>	£600



	sDrive18i SE	sDrive18i Sport	sDrive18i xLine	sDrive18i M Sport	sDrive20i SE	sDrive20i Sport	sDrive20i xLine	sDrive20i M Sport	xDrive20i SE	xDrive20i Sport	xDrive20i xLine	xDrive20i M Sport	xDrive25e Sport	xDrive25e xLine	xDrive25e M Sport	sDrive18d SE	sDrive18d Sport	sDrive18d xLine	sDrive18d M Sport	xDrive18d SE	xDrive18d Sport	xDrive18d xLine	xDrive18d M Sport	xDrive20d SE	xDrive20d Sport	xDrive20d xLine	xDrive20d M Sport	Price
--	--------------	-----------------	-----------------	-------------------	--------------	-----------------	-----------------	-------------------	--------------	-----------------	-----------------	-------------------	-----------------	-----------------	-------------------	--------------	-----------------	-----------------	-------------------	--------------	-----------------	-----------------	-------------------	--------------	-----------------	-----------------	-------------------	-------

INTERIOR EQUIPMENT

Extended lighting Included within Comfort Pack I	<input type="checkbox"/>	<input type="checkbox"/>	<input checked="" type="checkbox"/>	<input checked="" type="checkbox"/>	<input type="checkbox"/>	<input type="checkbox"/>	<input checked="" type="checkbox"/>	<input checked="" type="checkbox"/>	<input type="checkbox"/>	<input type="checkbox"/>	<input checked="" type="checkbox"/>	<input checked="" type="checkbox"/>	<input type="checkbox"/>	<input checked="" type="checkbox"/>	<input checked="" type="checkbox"/>	<input type="checkbox"/>	<input type="checkbox"/>	<input checked="" type="checkbox"/>	<input checked="" type="checkbox"/>	<input type="checkbox"/>	<input type="checkbox"/>	<input checked="" type="checkbox"/>	<input checked="" type="checkbox"/>	<input type="checkbox"/>	<input type="checkbox"/>	<input checked="" type="checkbox"/>	<input checked="" type="checkbox"/>	n/a
Luggage compartment separating net	<input type="checkbox"/>	<input type="checkbox"/>	<input type="checkbox"/>	<input type="checkbox"/>	<input type="checkbox"/>	<input type="checkbox"/>	<input type="checkbox"/>	<input type="checkbox"/>	<input type="checkbox"/>	<input type="checkbox"/>	<input type="checkbox"/>	<input type="checkbox"/>	<input type="checkbox"/>	<input type="checkbox"/>	<input type="checkbox"/>	<input type="checkbox"/>	<input type="checkbox"/>	<input type="checkbox"/>	<input type="checkbox"/>	<input type="checkbox"/>	<input type="checkbox"/>	<input type="checkbox"/>	<input type="checkbox"/>	<input type="checkbox"/>	<input type="checkbox"/>	<input type="checkbox"/>	<input type="checkbox"/>	£150
Panoramic glass sunroof	<input type="checkbox"/>	<input type="checkbox"/>	<input type="checkbox"/>	<input type="checkbox"/>	<input type="checkbox"/>	<input type="checkbox"/>	<input type="checkbox"/>	<input type="checkbox"/>	<input type="checkbox"/>	<input type="checkbox"/>	<input type="checkbox"/>	<input type="checkbox"/>	<input type="checkbox"/>	<input type="checkbox"/>	<input type="checkbox"/>	<input type="checkbox"/>	<input type="checkbox"/>	<input type="checkbox"/>	<input type="checkbox"/>	<input type="checkbox"/>	<input type="checkbox"/>	<input type="checkbox"/>	<input type="checkbox"/>	<input type="checkbox"/>	<input type="checkbox"/>	<input type="checkbox"/>	<input type="checkbox"/>	£1,000
Sun protection glass Included within M Sport Pro Pack	<input type="checkbox"/>	<input type="checkbox"/>	<input type="checkbox"/>	<input type="checkbox"/>	<input type="checkbox"/>	<input type="checkbox"/>	<input type="checkbox"/>	<input type="checkbox"/>	<input type="checkbox"/>	<input type="checkbox"/>	<input type="checkbox"/>	<input type="checkbox"/>	<input type="checkbox"/>	<input type="checkbox"/>	<input type="checkbox"/>	<input type="checkbox"/>	<input type="checkbox"/>	<input type="checkbox"/>	<input type="checkbox"/>	<input type="checkbox"/>	<input type="checkbox"/>	<input type="checkbox"/>	<input type="checkbox"/>	<input type="checkbox"/>	<input type="checkbox"/>	<input type="checkbox"/>	<input type="checkbox"/>	£300

SEATS

Seat heating, front Included within Comfort Pack I	<input type="checkbox"/>	<input type="checkbox"/>	<input checked="" type="checkbox"/>	<input checked="" type="checkbox"/>	<input type="checkbox"/>	<input type="checkbox"/>	<input checked="" type="checkbox"/>	<input checked="" type="checkbox"/>	<input type="checkbox"/>	<input type="checkbox"/>	<input checked="" type="checkbox"/>	<input checked="" type="checkbox"/>	<input type="checkbox"/>	<input checked="" type="checkbox"/>	<input checked="" type="checkbox"/>	<input type="checkbox"/>	<input type="checkbox"/>	<input checked="" type="checkbox"/>	<input checked="" type="checkbox"/>	<input type="checkbox"/>	<input type="checkbox"/>	<input checked="" type="checkbox"/>	<input checked="" type="checkbox"/>	<input type="checkbox"/>	<input type="checkbox"/>	<input checked="" type="checkbox"/>	<input checked="" type="checkbox"/>	n/a
Sliding rear seat bench	<input type="checkbox"/>	<input type="checkbox"/>	<input type="checkbox"/>	<input type="checkbox"/>	<input type="checkbox"/>	<input type="checkbox"/>	<input type="checkbox"/>	<input type="checkbox"/>	<input type="checkbox"/>	<input type="checkbox"/>	<input type="checkbox"/>	<input type="checkbox"/>	-	-	-	<input type="checkbox"/>	<input type="checkbox"/>	<input type="checkbox"/>	<input type="checkbox"/>	<input type="checkbox"/>	<input type="checkbox"/>	<input type="checkbox"/>	<input type="checkbox"/>	<input type="checkbox"/>	<input type="checkbox"/>	<input type="checkbox"/>	<input type="checkbox"/>	£350
Sport seats, front	-	<input checked="" type="checkbox"/>	<input type="checkbox"/>	<input checked="" type="checkbox"/>	-	<input checked="" type="checkbox"/>	<input type="checkbox"/>	<input checked="" type="checkbox"/>	-	<input checked="" type="checkbox"/>	<input type="checkbox"/>	<input checked="" type="checkbox"/>	<input checked="" type="checkbox"/>	<input type="checkbox"/>	<input checked="" type="checkbox"/>	-	<input checked="" type="checkbox"/>	<input type="checkbox"/>	<input checked="" type="checkbox"/>	-	<input checked="" type="checkbox"/>	<input type="checkbox"/>	<input checked="" type="checkbox"/>	-	<input checked="" type="checkbox"/>	<input type="checkbox"/>	<input checked="" type="checkbox"/>	£395

STEERING & CHASSIS

Adaptive suspension Not with M Sport suspension	-	-	-	<input type="checkbox"/>	-	-	-	<input type="checkbox"/>	-	-	-	<input type="checkbox"/>	-	-	-	-	-	-	<input type="checkbox"/>	-	-	-	<input type="checkbox"/>	-	-	-	<input type="checkbox"/>	£150
--	---	---	---	--------------------------	---	---	---	--------------------------	---	---	---	--------------------------	---	---	---	---	---	---	--------------------------	---	---	---	--------------------------	---	---	---	--------------------------	------

AUDIO & COMMUNICATION

Apple CarPlay® preparation ^{1,2,3}	<input checked="" type="checkbox"/>	<input checked="" type="checkbox"/>	<input checked="" type="checkbox"/>	<input checked="" type="checkbox"/>	<input checked="" type="checkbox"/>	<input checked="" type="checkbox"/>	<input checked="" type="checkbox"/>	<input checked="" type="checkbox"/>	<input checked="" type="checkbox"/>	<input checked="" type="checkbox"/>	<input checked="" type="checkbox"/>	<input checked="" type="checkbox"/>	<input checked="" type="checkbox"/>	<input checked="" type="checkbox"/>	<input checked="" type="checkbox"/>	<input checked="" type="checkbox"/>	<input checked="" type="checkbox"/>	<input checked="" type="checkbox"/>	<input checked="" type="checkbox"/>	<input checked="" type="checkbox"/>	<input checked="" type="checkbox"/>	<input checked="" type="checkbox"/>	<input checked="" type="checkbox"/>	<input checked="" type="checkbox"/>	<input checked="" type="checkbox"/>	<input checked="" type="checkbox"/>	<input checked="" type="checkbox"/>	Std
BMW Emergency Call ³	<input checked="" type="checkbox"/>	<input checked="" type="checkbox"/>	<input checked="" type="checkbox"/>	<input checked="" type="checkbox"/>	<input checked="" type="checkbox"/>	<input checked="" type="checkbox"/>	<input checked="" type="checkbox"/>	<input checked="" type="checkbox"/>	<input checked="" type="checkbox"/>	<input checked="" type="checkbox"/>	<input checked="" type="checkbox"/>	<input checked="" type="checkbox"/>	<input checked="" type="checkbox"/>	<input checked="" type="checkbox"/>	<input checked="" type="checkbox"/>	<input checked="" type="checkbox"/>	<input checked="" type="checkbox"/>	<input checked="" type="checkbox"/>	<input checked="" type="checkbox"/>	<input checked="" type="checkbox"/>	<input checked="" type="checkbox"/>	<input checked="" type="checkbox"/>	<input checked="" type="checkbox"/>	<input checked="" type="checkbox"/>	<input checked="" type="checkbox"/>	<input checked="" type="checkbox"/>	<input checked="" type="checkbox"/>	Std
BMW Navigation System	<input checked="" type="checkbox"/>	<input checked="" type="checkbox"/>	<input checked="" type="checkbox"/>	<input checked="" type="checkbox"/>	<input checked="" type="checkbox"/>	<input checked="" type="checkbox"/>	<input checked="" type="checkbox"/>	<input checked="" type="checkbox"/>	<input checked="" type="checkbox"/>	<input checked="" type="checkbox"/>	<input checked="" type="checkbox"/>	<input checked="" type="checkbox"/>	<input checked="" type="checkbox"/>	<input checked="" type="checkbox"/>	<input checked="" type="checkbox"/>	<input checked="" type="checkbox"/>	<input checked="" type="checkbox"/>	<input checked="" type="checkbox"/>	<input checked="" type="checkbox"/>	<input checked="" type="checkbox"/>	<input checked="" type="checkbox"/>	<input checked="" type="checkbox"/>	<input checked="" type="checkbox"/>	<input checked="" type="checkbox"/>	<input checked="" type="checkbox"/>	<input checked="" type="checkbox"/>	<input checked="" type="checkbox"/>	Std
BMW Online Services ^{1,4}	<input checked="" type="checkbox"/>	<input checked="" type="checkbox"/>	<input checked="" type="checkbox"/>	<input checked="" type="checkbox"/>	<input checked="" type="checkbox"/>	<input checked="" type="checkbox"/>	<input checked="" type="checkbox"/>	<input checked="" type="checkbox"/>	<input checked="" type="checkbox"/>	<input checked="" type="checkbox"/>	<input checked="" type="checkbox"/>	<input checked="" type="checkbox"/>	<input checked="" type="checkbox"/>	<input checked="" type="checkbox"/>	<input checked="" type="checkbox"/>	<input checked="" type="checkbox"/>	<input checked="" type="checkbox"/>	<input checked="" type="checkbox"/>	<input checked="" type="checkbox"/>	<input checked="" type="checkbox"/>	<input checked="" type="checkbox"/>	<input checked="" type="checkbox"/>	<input checked="" type="checkbox"/>	<input checked="" type="checkbox"/>	<input checked="" type="checkbox"/>	<input checked="" type="checkbox"/>	<input checked="" type="checkbox"/>	Std
BMW TeleServices ³	<input checked="" type="checkbox"/>	<input checked="" type="checkbox"/>	<input checked="" type="checkbox"/>	<input checked="" type="checkbox"/>	<input checked="" type="checkbox"/>	<input checked="" type="checkbox"/>	<input checked="" type="checkbox"/>	<input checked="" type="checkbox"/>	<input checked="" type="checkbox"/>	<input checked="" type="checkbox"/>	<input checked="" type="checkbox"/>	<input checked="" type="checkbox"/>	<input checked="" type="checkbox"/>	<input checked="" type="checkbox"/>	<input checked="" type="checkbox"/>	<input checked="" type="checkbox"/>	<input checked="" type="checkbox"/>	<input checked="" type="checkbox"/>	<input checked="" type="checkbox"/>	<input checked="" type="checkbox"/>	<input checked="" type="checkbox"/>	<input checked="" type="checkbox"/>	<input checked="" type="checkbox"/>	<input checked="" type="checkbox"/>	<input checked="" type="checkbox"/>	<input checked="" type="checkbox"/>	<input checked="" type="checkbox"/>	Std
Connected eDrive Services ^{1,3}	-	-	-	-	-	-	-	-	-	-	-	-	<input checked="" type="checkbox"/>	<input checked="" type="checkbox"/>	<input checked="" type="checkbox"/>	-	-	-	-	-	-	-	-	-	-	-	-	Std
Loudspeaker system – harman/kardon Included within M Sport Pro Pack	<input type="checkbox"/>	<input type="checkbox"/>	<input type="checkbox"/>	<input type="checkbox"/>	<input type="checkbox"/>	<input type="checkbox"/>	<input type="checkbox"/>	<input type="checkbox"/>	<input type="checkbox"/>	<input type="checkbox"/>	<input type="checkbox"/>	<input type="checkbox"/>	<input type="checkbox"/>	<input type="checkbox"/>	<input type="checkbox"/>	<input type="checkbox"/>	<input type="checkbox"/>	<input type="checkbox"/>	<input type="checkbox"/>	<input type="checkbox"/>	<input type="checkbox"/>	<input type="checkbox"/>	<input type="checkbox"/>	<input type="checkbox"/>	<input type="checkbox"/>	<input type="checkbox"/>	<input type="checkbox"/>	£600
Real Time Traffic Information (RTTI) ^{1,4}	<input checked="" type="checkbox"/>	<input checked="" type="checkbox"/>	<input checked="" type="checkbox"/>	<input checked="" type="checkbox"/>	<input checked="" type="checkbox"/>	<input checked="" type="checkbox"/>	<input checked="" type="checkbox"/>	<input checked="" type="checkbox"/>	<input checked="" type="checkbox"/>	<input checked="" type="checkbox"/>	<input checked="" type="checkbox"/>	<input checked="" type="checkbox"/>	<input checked="" type="checkbox"/>	<input checked="" type="checkbox"/>	<input checked="" type="checkbox"/>	<input checked="" type="checkbox"/>	<input checked="" type="checkbox"/>	<input checked="" type="checkbox"/>	<input checked="" type="checkbox"/>	<input checked="" type="checkbox"/>	<input checked="" type="checkbox"/>	<input checked="" type="checkbox"/>	<input checked="" type="checkbox"/>	<input checked="" type="checkbox"/>	<input checked="" type="checkbox"/>	<input checked="" type="checkbox"/>	<input checked="" type="checkbox"/>	Std
Remote Services ^{1,3}	<input checked="" type="checkbox"/>	<input checked="" type="checkbox"/>	<input checked="" type="checkbox"/>	<input checked="" type="checkbox"/>	<input checked="" type="checkbox"/>	<input checked="" type="checkbox"/>	<input checked="" type="checkbox"/>	<input checked="" type="checkbox"/>	<input checked="" type="checkbox"/>	<input checked="" type="checkbox"/>	<input checked="" type="checkbox"/>	<input checked="" type="checkbox"/>	-	-	-	<input checked="" type="checkbox"/>	<input checked="" type="checkbox"/>	<input checked="" type="checkbox"/>	<input checked="" type="checkbox"/>	<input checked="" type="checkbox"/>	<input checked="" type="checkbox"/>	<input checked="" type="checkbox"/>	<input checked="" type="checkbox"/>	<input checked="" type="checkbox"/>	<input checked="" type="checkbox"/>	<input checked="" type="checkbox"/>	<input checked="" type="checkbox"/>	Std

Not with = these options are not available for ordering together / = Indicates 'or' ¹ = Requires a free BMW ConnectedDrive account. ² = Compatibility and functions may vary due to the model year of the iPhoneR and the version of software installed on it. Functions using a data connection will use data from the SIM card in the iPhoneR. Additional data charges may be applied by the mobile network provider. ³ = Available and active without runtime limitations. Usage cannot be guaranteed permanently due to potential future technical developments (of the Service availability and/or Smartphone compatibility/operating systems). ⁴ = Available for 3 years, renewable thereafter.



sDrive18i SE	sDrive18i Sport	sDrive18i xLine	sDrive18i M Sport	sDrive20i SE	sDrive20i Sport	sDrive20i xLine	sDrive20i M Sport	xDrive20i SE	xDrive20i Sport	xDrive20i xLine	xDrive20i M Sport	xDrive25e Sport	xDrive25e xLine	xDrive25e M Sport	sDrive18d SE	sDrive18d Sport	sDrive18d xLine	sDrive18d M Sport	xDrive18d SE	xDrive18d Sport	xDrive18d xLine	xDrive18d M Sport	xDrive20d SE	xDrive20d Sport	xDrive20d xLine	xDrive20d M Sport	Price
--------------	-----------------	-----------------	-------------------	--------------	-----------------	-----------------	-------------------	--------------	-----------------	-----------------	-------------------	-----------------	-----------------	-------------------	--------------	-----------------	-----------------	-------------------	--------------	-----------------	-----------------	-------------------	--------------	-----------------	-----------------	-------------------	-------

LIGHT ALLOY WHEELS

	17" V-spoke style 560	■	-	-	-	■	-	-	-	■	-	-	-	-	■	-	-	-	■	-	-	-	-	-	-	-	Std
	17" Double-spoke style 564	□	-	-	-	□	-	-	-	□	-	-	-	-	□	-	-	-	□	-	-	-	□	-	-	-	£0
	18" Y-spoke style 566	-	-	□	-	-	-	□	-	-	-	□	-	-	-	-	□	-	-	-	□	-	-	□	-	-	£0
	18" Double-spoke style 578, Jet Black	-	■	-	-	-	■	-	-	■	-	-	■	-	-	■	-	-	■	-	-	■	-	-	■	-	Std
	18" Y-spoke style 579, Bicolour	-	-	■	-	-	-	■	-	-	■	-	-	■	-	-	■	-	-	■	-	-	■	-	-	■	Std



sDrive18i SE	sDrive18i Sport	sDrive18i xLine	sDrive18i M Sport	sDrive20i SE	sDrive20i Sport	sDrive20i xLine	sDrive20i M Sport	xDrive20i SE	xDrive20i Sport	xDrive20i xLine	xDrive20i M Sport	xDrive25e Sport	xDrive25e xLine	xDrive25e M Sport	sDrive18d SE	sDrive18d Sport	sDrive18d xLine	sDrive18d M Sport	xDrive18d SE	xDrive18d Sport	xDrive18d xLine	xDrive18d M Sport	xDrive20d SE	xDrive20d Sport	xDrive20d xLine	xDrive20d M Sport	Price
--------------	-----------------	-----------------	-------------------	--------------	-----------------	-----------------	-------------------	--------------	-----------------	-----------------	-------------------	-----------------	-----------------	-------------------	--------------	-----------------	-----------------	-------------------	--------------	-----------------	-----------------	-------------------	--------------	-----------------	-----------------	-------------------	-------

LIGHT ALLOY WHEELS

	19" Y-spoke style 511	-	□	-	-	-	□	-	-	-	□	-	-	-	-	□	-	-	-	□	-	-	-	-	-	£550
	18" M Double-spoke style 570 M	-	-	-	■	-	-	■	-	-	-	■	-	-	■	-	-	-	-	-	-	■	-	-	-	Std
	19" Y-spoke style 580, Bicolour	-	-	□	-	-	-	□	-	-	-	□	-	-	-	□	-	-	-	-	□	-	-	-	-	£550
	19" M Double-spoke style 816 M, Bicolour Only with M Sport Pro Pack	-	-	-	□	-	-	-	-	-	-	□	-	-	-	□	-	-	-	-	□	-	-	-	-	n/a
		-	-	-	-	-	-	-	-	-	-	-	-	-	-	-	-	-	-	-	-	-	-	-	-	£550



xDrive25e Sport	xDrive25e xLine	xDrive25e M Sport
-----------------	-----------------	-------------------

Price

360° ELECTRIC

Digital Charging Service – 12 months subscription ¹	■	■	■	n/a
Home charging: BMW i Wallbox Connect (32 Amp) with Standard Installation ²	□	□	□	From £975 ⁺
Public Charging: BMW i AC Rapid Charge Cable (5 metre length) – Max 32 Amp 3-phase public charging cable, Type 2 connectors	■	■	■	n/a
Public Charging: BMW i AC Fast Charge Cable (8 metre length) – Max 32 Amp 1-phase public charging cable, Type 2 connectors	□	□	□	£195
Public charging: ChargeNow – Pay as you go charging ³	□	□	□	£7.85 per month
Assistance Services – BMW i Mobile Care – Battery Warranty – Vehicle Warranty	■	■	■	n/a



+ = Subject to OLEV subsidy and qualification which may be liable to change, for further details please speak to your local BMW Centre. For more information about Plug-In Hybrid Electric Vehicles please visit <https://www.bmw.co.uk/en/topics/discover/electric-and-phev/plug-in-hybrids.html> ¹ = 12 months subscription from production date only, renewable thereafter for £45 per annum via the ConnectedDrive Store. ² = Includes 3 year warranty. ³ = Available as a stand alone service. Terms and Conditions apply, find out more at www.chargenow.com The design of the charging cable may vary from image shown. Content correct at time of publishing. Prices subject to change.

DIMENSIONS.

THE BMW X1.

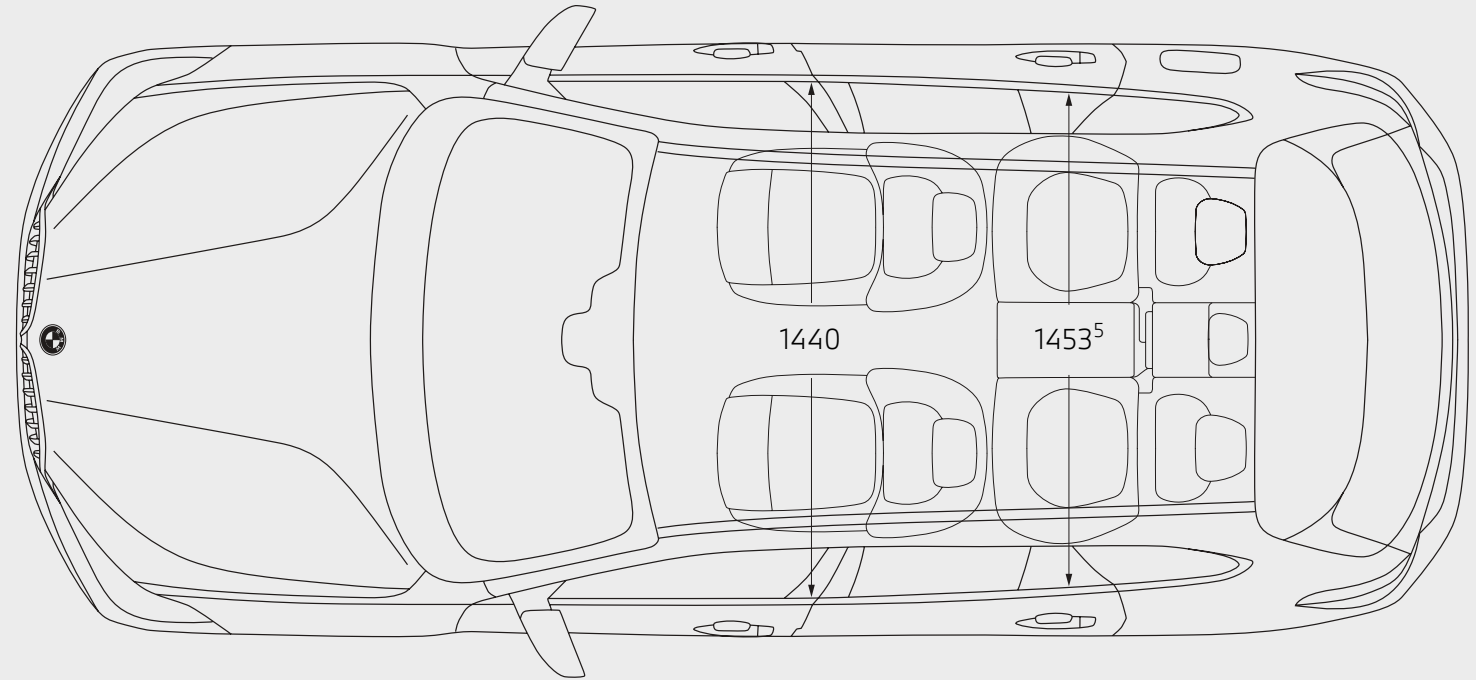
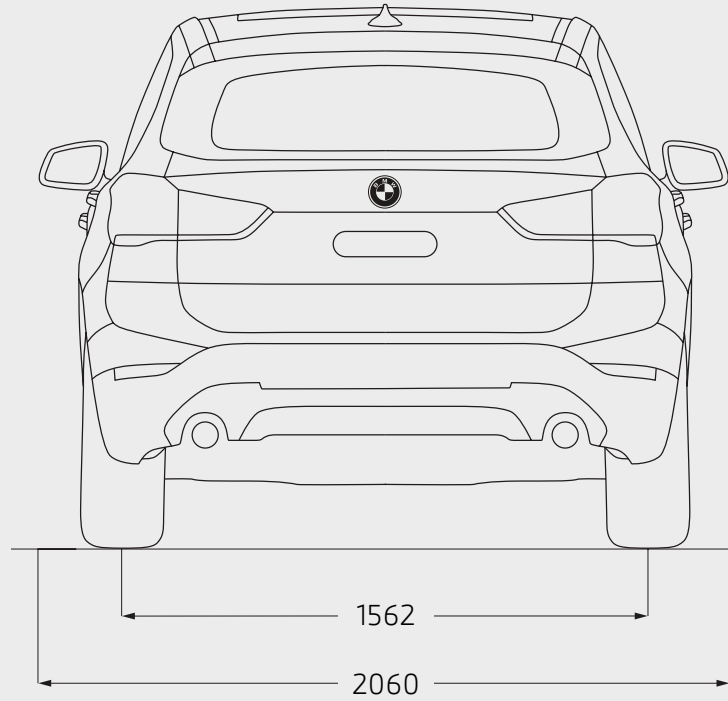
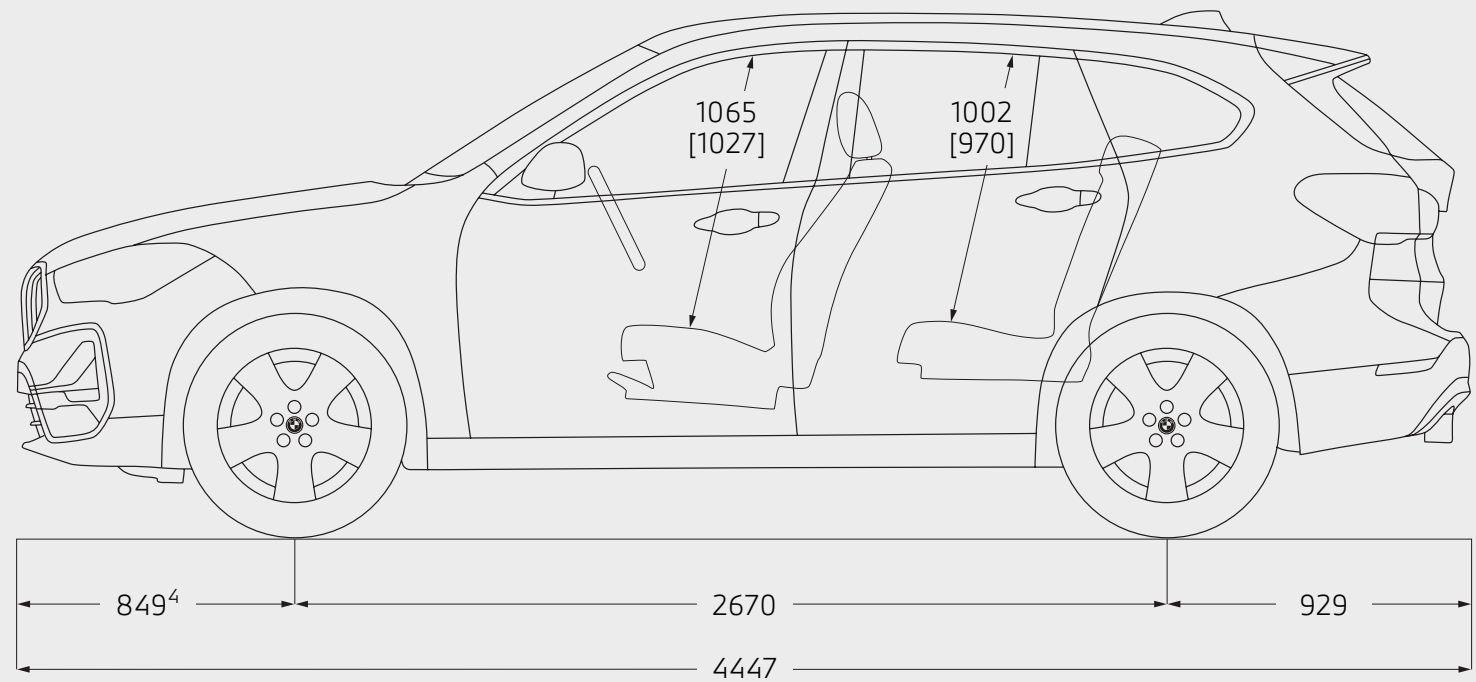
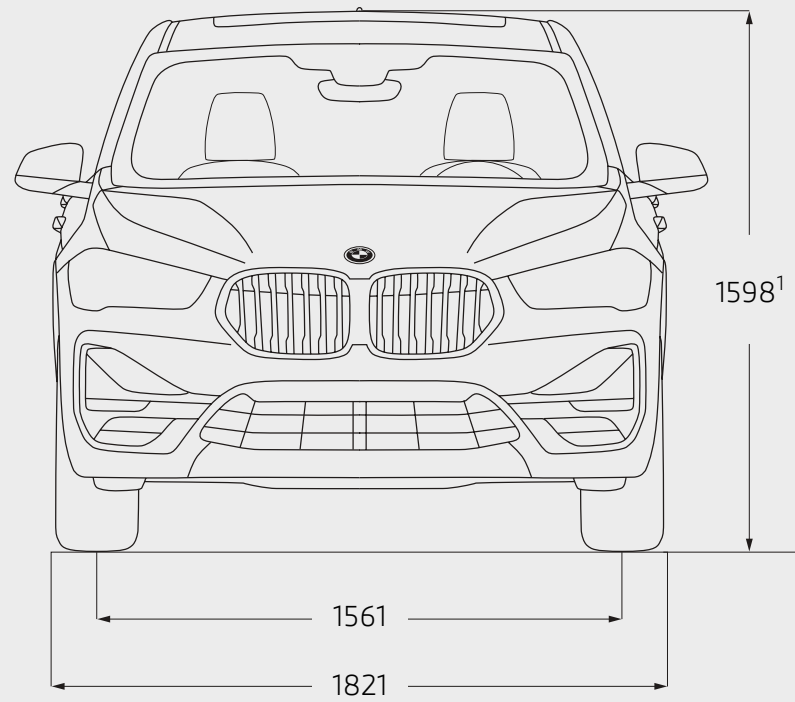

Length (mm)	4447	Height (mm)	1598 ¹	Number of seats	5	Turning circle (m)	11.4 ²
Width (mm)	1821	Width including mirrors (mm) (Driver / Passenger)	2060 (1035 / 1025)	Wheelbase (mm)	2864	Luggage capacity (litre)	505-1550 ³

¹ = xDrive25e: 1582mm. ² = xDrive25e: 11.7mm. ³ = xDrive25e: 450-1470 litres. ⁴ = xDrive25e: 848mm. ⁵ = xDrive25e: 1452mm. Figures in [] apply to cars fitted with Panoramic glass sunroof.

BMW PAY MONTHLY SERVICING & TRACKSTAR.

SERVICING MADE SIMPLE.

Planning for the road ahead has never been easier. With the BMW Pay Monthly Service Plan¹ you can remove the uncertainty often associated with car servicing costs by spreading them monthly, much like you would your household bills. Our Pay Monthly service plan covers two services and any unused credit can be transferred to another BMW if you decide to switch unexpectedly. As part of the Pay Monthly plan you will also receive a number of added extras including:

- Fluid top ups
- An MOT
- A Wash & Vac each time you visit
- Seasonal health checks
- Sat Nav Map updates

Get the quality service and parts you expect from BMW with a fixed monthly payment. Give your BMW the care and attention it deserves from the experts that made it.

Price: £20 per month for 36 months

Please contact your preferred BMW Centre for further information.

BMW TRACKSTAR.

Locate and recover your vehicle if it is stolen with BMW Trackstar or BMW Trackstar Advance. Benefits include:

- 24/7 Trackstar Monitoring Centre
- Thatcham accredited
- Integrated motion sensor
- Pan-European protection

BMW Trackstar S7 price from: £399²

BMW Trackstar S5 price from £549²

BMW Trackstar S5 Advance price from: £649²



BMW CONNECTED DRIVE SERVICES.

BMW ConnectedDrive keeps driver and vehicle connected with the outside world. Digital services, driver-focused technologies and driver assistance systems provide more comfort, more entertainment and more safety. Increase your driving pleasure – with BMW ConnectedDrive.

For further information on BMW ConnectedDrive and the General Terms and Conditions of Service for ConnectedDrive, please see: www.bmw.co.uk/connecteddrive-information

The BMW ConnectedDrive Hotline is available on: +44 (0) 800 561 0555 from Monday to Friday 8am – 7pm and Saturday to Sunday 9am – 5pm.

CONNECTED DRIVE SERVICES DURATION

Online Entertainment	1 year
BMW Online Services	3 years
Real Time Traffic Information	3 years
Apple CarPlay® preparation	Available and active without runtime limitations.
BMW Emergency Call	Available and active without runtime limitations.
BMW TeleServices	Available and active without runtime limitations.
Connected eDrive Services	Available and active without runtime limitations.
Remote Services	Available and active without runtime limitations.

GENERAL INFORMATION

BMW (UK) Ltd, Summit ONE, Summit Avenue, Farnborough, Hampshire, GU14 0FB (hereinafter referred to as "BMW") provides the customer with certain vehicle-related information and assistance functions (hereinafter called "Services") under the name of "BMW ConnectedDrive". BMW collects, stores or processes car-related data in compliance with applicable law and only to the extent necessary to provide the Services. BMW does not collect, store or process personal data in course of the Services – except where this is explicitly stated in the service description of the individual Services. In the case of Services that require personal data to be collected, stored and processed so that such Services can actually be provided, BMW informs customers of this in advance by providing this data protection notice. The Services are provided by means of a SIM card installed in the vehicle.

AVAILABILITY OF THE SERVICE

The complete range of Services is only available for customers whose vehicles are approved in United Kingdom, and only within United Kingdom.

"BMW Emergency Call" is available to customers in United Kingdom, Germany, Austria, Italy, San Marino, Vatican, France, Monaco, Switzerland, Liechtenstein, Belgium, Luxembourg, the Netherlands, Ireland, Spain, Andorra, Portugal, Sweden, Norway, Czech Republic, Poland, Turkey and Russia "TeleServices", "Concierge services", "Remote Services" and "BMW Online" can be accessed on any mobile communication network in Europe. When used abroad, the range and characteristics of the service may vary from the range and characteristics described above and may vary from country to country. "Real Time Traffic Information" is available in United Kingdom, Germany, Austria, Italy, France, the Netherlands, Switzerland, Belgium, Republic of Ireland, Spain, Portugal, Sweden and Norway. "Online Entertainment" is available for use in United Kingdom, Germany, France, Italy, Spain, Belgium, Luxembourg, the Netherlands, Austria and Switzerland.

DEACTIVATION

You can have the BMW ConnectedDrive services deactivated through an authorised BMW centre, a BMW subsidiary or a BMW authorised workshop at any time. This also has the consequence that aspects of the emergency call in the vehicle as well as all remaining Services will no longer function.

You can additionally arrange for the remaining Services to be deactivated via "My BMW ConnectedDrive".

If the vehicle is equipped with the legally required EU Emergency Call (as from April 2018) a deactivation of the BMW ConnectedDrive basic services will not deactivate the vehicle's built-in SIM card. It has to remain active, so that the EU Emergency Call is functional all the time.

Services that are available and active without runtime limitations, cannot be guaranteed for permanent usage due to potential future technical developments (of the Service availability and/or Smartphone compatibility/ operating systems).





READY TO TAKE THE NEXT STEP?

