

UX



SELF-CHARGING HYBRID



"Our aim for the new UX was not to conform to the established crossover look, but to break with convention and create something more distinctive and dynamic."

UX CHIEF ENGINEER
CHIKA KAKO

EXPERIENCE AMAZING

The Lexus UX compact SUV challenges everything that went before. Whilst its bold design expresses unmistakable strength, the elegantly sculpted surfaces suggest a character that is both stylish and dynamic. The result is a car with a unique presence on the road.

Inside the UX you'll enjoy the commanding seating position and excellent visibility of a modern

SUV, yet these are combined with a level of dynamic performance equalling that of a hatchback. Thanks to a rigid new platform and low centre of gravity, the UX is reassuringly stable and fun to drive. With our fourth generation Lexus Self-Charging Hybrid it combines class-leading fuel efficiency with extremely smooth performance. It is also available as a distinctive F SPORT model.

Every Lexus comes with a wealth of imaginative technology and the UX is no exception. Take for example, Lexus Safety System +, one of the multiple features allows the UX to detect pedestrians at night and even cyclists during the daytime.



01. BRAVE DESIGN

UX Chief Designer, Tetsuo Miki, introduces his latests creation at INTERSECT BY LEXUS in Tokyo.

Pages 6-9

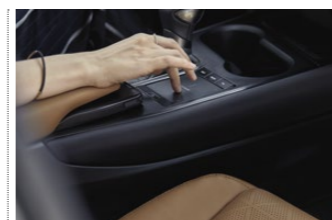

02. IMAGINATIVE TECHNOLOGY

Discover imaginative technology such as Lexus Safety System +.

Pages 10-13



03. EXHILARATING PERFORMANCE

Experience the UX in the Netherlands with Chief Engineer, Chika Kako.

Pages 14-21

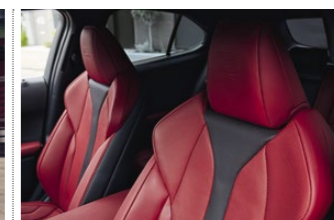

04. TAKUMI CRAFTSMANSHIP

Read how traditional aikido uniforms influenced UX seat stitching.

Pages 22-23



05. NEW HORIZONS

The UX represents a new genre of hybrid compact SUV, built to explore new horizons.

Pages 24-25



06. SELF-CHARGING HYBRID

Discover more about the pioneering UX Self-Charging Hybrid.

Pages 26-29



07. GRADE LINE-UP

Three grades are available; UX, F SPORT and Takumi with a range of optional packs.

Pages 30-31



08. FEATURES

Find out about the amazing level of features available for your new UX.

Pages 32-35



09. TECHNOLOGY

Discover the technology in the UX Hybrid.

Pages 36-39



10. F SPORT

For a more dynamic driving experience, discover the UX F SPORT.

Pages 40-41



11. ACCESSORIES

Explore the range of accessories created by Lexus to enhance your enjoyment of the UX.

Pages 42-43

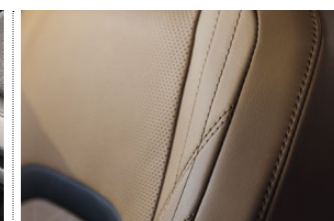

12. COLOURS

Select your favourite exterior colour and specify a 'Takumi'-crafted interior that will welcome you every time you drive your new UX.

Pages 44-49



13. EQUIPMENT

Discover the level of standard equipment by grade.

Pages 50-52



14. ADDITIONAL BENEFITS

Discover more about three years' free Lexus Roadside Assistance and learn more about our Hybrid Health Check.

Page 53



15. TECHNICAL DATA

Study all the key technical data before ordering your UX.

Pages 54-55



16. THE LEXUS EXPERIENCE

Learn how we aim to treat every customer as if they were a guest in our home.

Pages 58-59



Tokyo: the world's largest megacity, with 36 million inhabitants. We're here to meet one man, and one car. Lexus has created INTERSECT BY LEXUS. It's a place guests can come to relax, be inspired and engage with all Lexus things. First impressions are stunning.

At reception we're welcomed by Tetsuo Miki, Chief Designer of the new Lexus UX. He's going to give us a personal introduction to his latest creation: a new compact SUV created for cities like Tokyo. But first he shares his own personal take on INTERSECT BY LEXUS: "It's a way of bringing the Lexus values to life in a unique space," he says. "People can come here to enjoy amazing experiences that are a cut above the ordinary."

Miki-san takes us through to 'The Garage' - a flexible space that can serve as an art gallery or event location. Today it's the stage for the Lexus UX Hybrid, which looks very much at home in this stylish environment. The car is bold, as you might expect from an urban SUV designed by Lexus. This is combined with a sophisticated dynamism which is utterly captivating. Miki-san tells us how it was done: "Look at the surfaces. See how sensuous and full of life they are... the way they contrast with the strong, rugged outline and stance of the car? Energy and personality like this cannot be created digitally. In fact, a Lexus really comes to life when our 'Takumi' master craftspeople start sculpting the clay prototype. Giving a 'soul' to industrial products is something intrinsically Japanese."

Needing little encouragement from us, he points out some details that he and his team are especially excited about. The headlights are a particular favourite. Each is made up of a compact pod of three LED units which, together with the arrowhead-shaped Daytime Running Lights and

a big contribution to the car's handling and performance. "When we test drove the car, we really felt how the aerodynamic fins integrated in the rear light gave the vehicle much more stability," says the Chief Designer. "That was the icing on the cake - not just beauty but function too."

Time now to admire the interior. The UX Hybrid has relatively compact exterior dimensions, but the team wanted to ensure that the inside felt open and spacious. One of their solutions was inspired by the brand's cultural heritage. Miki-san explains: "Japanese houses often have a veranda, which blurs the boundary between the inside and the outside - so you can pass easily from one to the other. The Lexus UX has something similar: we've made a seamless connection between the inside and outside of the car - so the upper section of the instrument panel appears to extend beyond the windshield to the exterior. It gives you a nice open feeling and if you're the driver it means you get a good sense of the extremities of the car, making it much easier to manoeuvre in confined spaces."

While we're experiencing this from the driver's seat, we are able to take in other pleasing aspects of the interior: the way, for example, that everything of importance is located around the driver, with all the controls falling naturally to hand (there's a clever centre console with a palm rest that has the audio controls built in). Then there's the comfort of the quilted seat backs, and the elegant "less is more" approach, which makes the interior feel so relaxed and uncluttered.

THE URBAN EXPLORER

INTERSECT BY LEXUS

TOKYO

4-21-26 Minami-Aoyama, Minato-ku, Tokyo, Japan

DUBAI

DIFC, Gate Village Building 7, Dubai, United Arab Emirates

NEW YORK

412 W 14th St, New York, NY 10014, USA

Lexus signature grille, give a strong character to the car's face. At the rear, the ultra thin one-piece LED combination light is beautifully shaped. But it's more than that. Amazingly, it makes

- 01 Driver-focused cockpit with class-leading field of vision
- 02 Dynamic SUV looks with bold F SPORT Lexus signature grille and 3-EYE LED headlights
- 03 The LED rear light is shaped to improve the UX's handling and performance
- 04 Experience brave design and exquisite craftsmanship at INTERSECT BY LEXUS



01



02

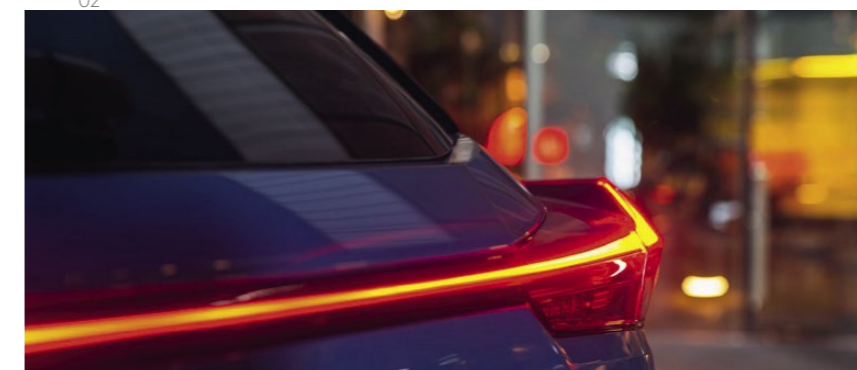

03

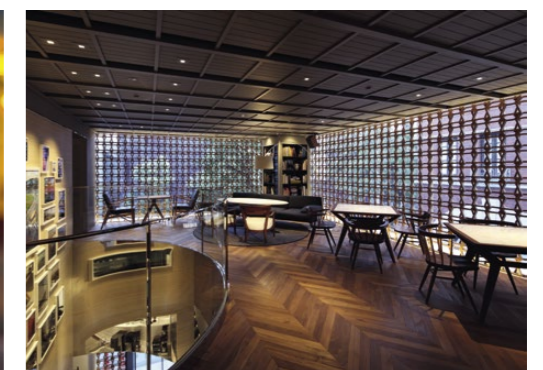

04



View Offers



Build Your UX



Find a Centre



Book a Test Drive





01

- 01 Dashboard can show information such as GForce
- 02 10.3-inch multimedia display with Panoramic View Monitor**
- 03 10.2-inch Head-Up Display (HUD)



A COCKPIT BUILT AROUND YOU

Slide into the driver's seat of the new UX Hybrid and you will quickly find the perfect driving position. The seat is extremely inviting, giving you an ideal view of the road ahead. With the hand-stitched leather steering wheel in your hands, gear shifts exude sportiness thanks to paddle shift controls* mounted on the steering column. Accelerator response is instant using 'shift-by-wire' technology. The UX's ergonomic dashboard has been designed to keep all distractions to a minimum and features innovative ideas like a wireless phone charger and wireless air vent illumination.

Perfectly positioned for a relaxing drive, the UX's 10.3" multimedia display. Now with Apple CarPlay® and Android Auto®, you can effortlessly control selected apps from your phone, using the Touch Pad or voice commands. Use Maps to guide you to your

final destination, displaying your route clearly on the Lexus Navigation screen, as well as its split-screen allowing you to simultaneously access information, such as climate data.

For easier driving in the city, the Panoramic View Monitor uses multiple cameras to provide a near-360°*** view around the entire car. It also creates a virtual 3D picture of your UX, showing the vehicle as if seen from above, with on-screen guides to assist close-quarter manoeuvring. Using technology first developed for jet fighter aircraft, the UX's large high-resolution colour Head-Up Display (HUD) is positioned unobtrusively in your field of vision and projects key information onto the windscreen. It creates an image so crisp and sharp that even in the very brightest sunlight you'll have no problem viewing the data.



02



03

* Paddle shifters are only available on the F SPORT grade as standard.

** The 10.3" is available with the Premium Plus Pack and Takumi pack on F SPORT and standard on Takumi grade.

*** Only available with the Takumi pack on F SPORT and standard on Takumi.

SAFE IN THE CITY WITH LEXUS SAFETY SYSTEM +

Wherever you venture in the new Lexus UX Hybrid, it is reassuring to know that you're driving in one of the safest SUV's ever built. The UX is equipped with the very latest Lexus Safety System + (LSS+) comprising advanced technology that helps prevent three of the most common accident types: rear-end collisions, lane departures and collisions involving pedestrians.

Driving on crowded motorways, or when commuting to and from work, the main dangers are drifting into another lane or failing to notice that the traffic ahead has slowed down. For this reason, when you start to change lane, the UX instantly monitors vehicles behind using Blind Spot Monitor (BSM) or slows down using Dynamic Radar Cruise Control (DRCC) if the vehicle ahead brakes.

The UX also features Road Sign Assist (RSA), which gathers information from road signs ahead; Automatic High Beam (AHB) that senses vehicles ahead at night; and Lane Tracing Assist (LTA), which is particularly helpful when cornering or driving on motorways.

Driving through busy downtown shopping areas, you'll be thankful for the UX's Pre-Collision System (PCS) Day & Night. Using millimetre-wave radar combined with a stereo camera, it even detects pedestrians at night or bicycles appearing suddenly in front during daytime. If it senses danger, you receive a visible warning in the Head-Up Display (HUD) so you can take appropriate measures to avoid an impact. And if you still don't take action, the UX will increase brake pressure to help prevent a collision.

- 01 Manoeuvre safely using optional Rear Cross Traffic Alert (RCTAB)/Auto Braking
- 02 Road Sign Assist (RSA) gathers information from road signs
- 03 Blind Spot Monitor (BSM) will detect vehicles in adjacent lanes

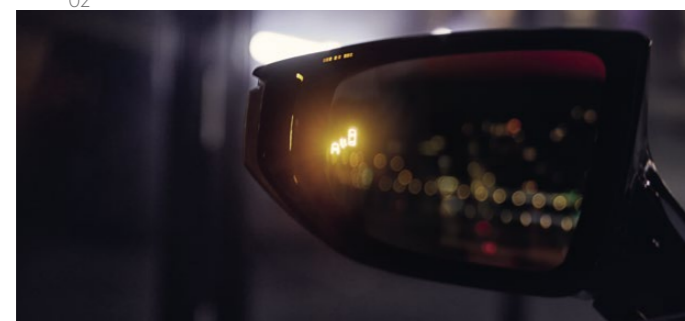

View Offers



Build Your UX



Find a Centre



Book a Test Drive



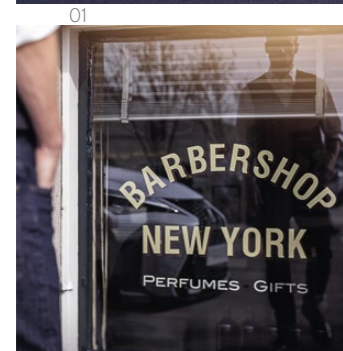

- 01 The UX has a unique design utilising advanced aerodynamics
- 02 The UX F SPORT features an even bolder signature grille
- 03 Exclusive F SPORT suspension tuning includes unique springs and stabiliser bars, plus a rear performance damper for a more engaging drive

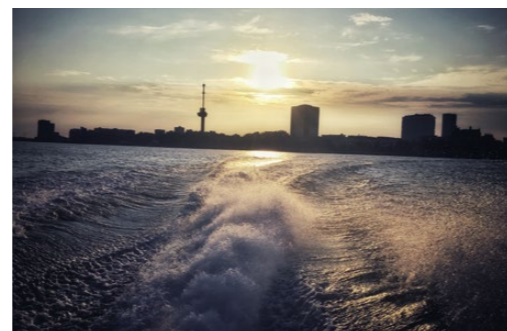

DISCOVER NEW HORIZONS IN THE NEW LEXUS UX HYBRID

This morning, it's room service all the way. I am staying in a fabulous design hotel in Rotterdam - a favourite city of mine - looking down onto the Rijnhaven side of Europe's biggest port. Container ships, water taxis, even an early morning cruise ship, motor serenely in and out of the harbour. Breakfast bliss.

My room with a view is perfect for daydreaming but I have too much to do, beginning with a 'cut-throat' razor shave at the hotel's renowned barbershop. Having a proper, old-fashioned shave - hot towel, fragrant foam, followed by the deft, precise strokes

of the blade - is one of life's indulgences. The guys in the barbershop are cool. I mention that I'll be in Amsterdam later that day and one of them recommends an espresso bar in the city's Sloterdijk district.

Outside, a gleaming Lexus UX Hybrid glides into view. Behind the wheel is Chief Engineer Chika Kako, my driving date for the day. I have been looking forward to this for months; an opportunity to discuss the new UX SUV with the engineer who oversaw the project from concept to production.



03

02

01

View Offers



Build Your UX



Find a Centre



Book a Test Drive





01



02



- 01 F SPORT exclusive 18" five twin-spoke alloy wheels underline the SUV's dynamic styling and are even more rigid than standard UX wheels, contributing to greater responsiveness and handling agility
- 02 A highly rigid platform is the foundation for the UX's agile performance

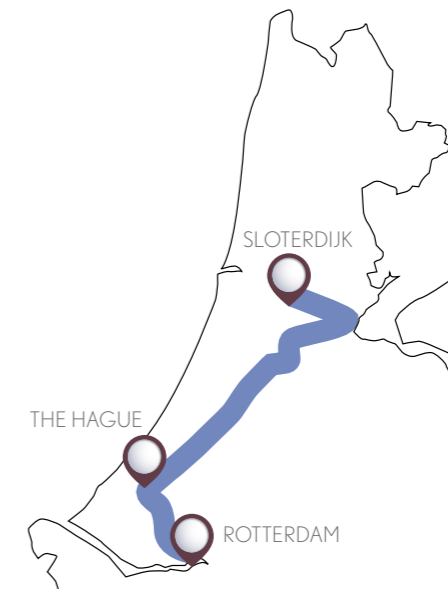

THE DRIVE

First we head west, before joining the A4 towards Amsterdam. Immediately I notice how quiet the car is; smooth as silk as we accelerate up to cruising speed. "That's a big part of it," Kako-san nods when I mention how refined the car seems. "For me, there's more to performance than speed alone. It's about feeling truly connected to the vehicle, the road, your senses."

"Once drivers get behind the wheel of the UX," she adds, "they quickly notice that it has a very distinctive driving character."

I ask how she achieved this distinction. "Okay, but stop me if I talk too much!" she laughs. "First, we created the building blocks of a really great car. I wanted to get away from the idea of the unwieldy SUV and develop a car as fun to drive as a hatchback."

"To do that, we engineered a new chassis platform, suspension and powertrains," she continues. "But developing the character of the UX required more than just ticking the performance boxes."

We're now on the outskirts of Amsterdam and Kako-san, who spent several years working in Europe, wants to show me the new IJburg area, a collection of three artificial islands created to help ease Amsterdam's housing shortage. Already home to 10,000 people, it's a marvel of urban planning with a strong emphasis on connectivity. The development features new roads, cycleways, bridges, even a tramline, with a diverse range of architectural styles.

We complete our tour and head west towards old Amsterdam. Kako-san pulls over in the trendy Jordaan district and we swap seats to give me a sense of the UX's cornering and refinement. Powered by the latest Lexus Self-Charging Hybrid, on the narrow, cobbled streets, the UX runs on electricity for much of the time. Compared to conventional SUVs, the UX is a dream to drive, as agile as anything you can imagine.

"That's probably the most pleasing aspect for me," says Kako-san. "We worked very closely with one of Lexus' 'Takumi' Master Drivers, Yoshiaki Ito, using the LC coupé as our benchmark."

"Here for example" - we're approaching a roundabout - "you'll sense a smooth and rhythmic flow as you brake, steer and accelerate again." She is right. This is not so much a mechanical experience as a sensory one; a feeling of one-ness.

I mention that coffee bar in Sloterdijk and Kako-san nods enthusiastically. It's just a 15-minute drive away, so I savour every single turn and boost of power, including parking in a very tight spot next to a café built from red shipping containers.

"The UX has the widest field of vision for this kind of SUV," she says, enjoying her barista-brewed cappuccino. "And the best turning radius in class, making it really easy to manoeuvre in the city."

All too soon, it's time for me to catch my train. Kako-san kindly offers me a lift to the new Amsterdam Central Station; even in this ultra-connected city of e-bikes, e-taxis and everything else, I gratefully accept. Spending time in the Netherlands has given me a glimpse of the future of urban mobility, and the exciting role cars like the Lexus UX Hybrid have to play in that future.



PIONEERING LEXUS SELF-CHARGING HYBRID

LEXUS SELF-CHARGING HYBRID

The UX is powered by the latest fourth generation Lexus Hybrid technology that features a new 2.0-litre four-cylinder petrol engine, powerful electric motors and newly developed hybrid automatic transmission. The engine resets benchmarks with its high thermal efficiency and output. Importantly, Lexus engineers focused not just on outstanding fuel economy, but also on a high level of driving appeal and vehicle performance.

E-FOUR

Already proven on the RX and NX, the optional E-FOUR gives the UX Hybrid All-Wheel Drive capability by placing an additional electric motor on the rear axle. Power distribution between the front and rear axles is automatically optimised when accelerating, cornering or driving on slippery surfaces.

[View Offers](#)

[Build Your UX](#)

[Find a Centre](#)

[Book a Test Drive](#)



DEVELOPED BY A 'TAKUMI' MASTER DRIVER FOR A SUPERIOR DRIVING FEEL

NEW PLATFORM

The UX features a highly rigid platform as the foundation for its exhilarating performance. By using a new platform, our engineers were able to increase overall strength, including around the critical rear door and tailgate openings. Advanced adhesives and laser screw welding are used in key locations, greatly enhancing overall rigidity.

LOW CENTRE OF GRAVITY

The UX has the lowest centre of gravity of any vehicle in its class. This characteristic, central to its agility and refinement, is complemented by a number of weight-saving measures. These include the use of lightweight aluminium for the doors, wings and bonnet, as well as a resin material for the tailgate. Important for the city, the UX compact proportions allow for a best-in-segment 5.6 metre turning radius.

INNOVATIVE AERODYNAMICS

Developed in the Lexus wind tunnel, one of the most advanced of its kind, the UX engineers took a radical new approach to achieving best possible aerodynamic performance. Breakthroughs include an aero stabilising rear light with fins that makes a noticeable contribution to overall stability, stepped wheel arch mouldings that help reduce roll and keep the vehicle stable, and wheels with motorsport-inspired aerodynamics to keep the brakes cool and reduce wind resistance.

ADAPTIVE VARIABLE SUSPENSION (AVS)

Not only does the F SPORT grade feature specially tuned suspension, with adjustment to springs and stabiliser bars, and the use of rear performance dampers, it also offers a specifically adapted version of the new high-response AVS system featured on the Lexus LC coupé. This is available as an option with the F SPORT with Tech & Safety and F SPORT with Takumi Pack.



HIDDEN SECRETS: INSPIRED JAPANESE TAKUMI CRAFTSMANSHIP



Journeys to Japan promise much, and then invariably over-deliver. So it is proving with my visit to the Lexus car plant here at Kyushu in southwestern Japan, where the new Lexus UX Hybrid SUV is made. I'm struggling with that word. The UX is manufactured here, but it's not really made here. The inspiration behind the car is so rich and so far-flung that it seems too limiting to attribute its origin to a car facility, even one as impressive as this.

Indeed, my story itself is already more colourful than I ever imagined. Much like Japan, you might say.

There was the aikido club in downtown Fukuoka where I found myself last night with UX Interior Designer, Keiko Shishido, who is responsible for paint colour development and cabin materials at Lexus. Now why arrange to meet in a martial arts hall? No matter, Shishido-san is instantly absorbing. Her petite, stylish appearance is at odds with the brute strength of the club, yet she immediately commands your attention, her words drawing from everyday concepts seemingly unconnected with the final creation: the art galleries she loves to frequent, the hours she spends watching people on the street, the ideas she is constantly storing.

It is refreshing to converse with a car person whose horizon stretches so far beyond the automotive industry. She sees a world where colours abound, in the clothes we wear, the home interiors we select, the foods we eat. She wants people to be able to exercise the same preferences when they choose their cars.

One of the aikido masters approaches. A friend of Shishido, I presume. He is taller than her, but I'm still perplexed as to why her attention is on his quilted 'aikido gi', or garment, and not his face. She asks me did I notice the intricate stitching. This is the 'sashiko' technique, over 1,200 years old, featuring up to 10 stitches per inch, whose strength makes it popular in aikido. Apparently, this stitching technique was also put to good use by early Japanese fire

fighters, with 'sashiko' stitching covering a single long coat of three layers of cotton. Now this craft form is being used on the leather seats of the new Lexus UX. Requiring a steady, skilful hand that is honed over many years, 'sashiko' quilting is executed by Lexus' 'Takumi' craftspeople. Shishido smiles. The mystery is revealed.

There is more inspiration hiding in our less than promising surroundings. As we make to leave, my host points to the traditional Japanese 'shoji' paper sliding doors to our right. The grain pattern of the paper - known as 'washi' - is recreated in the texture of the UX's instrument panel, lending a distinctive atmosphere to the entire interior. In the same breath she tells me a colour designer is not an artist, that developing a car means working within fixed parameters. Shishido's art lies clearly in drawing external influences into this brief.

It's the following morning, and I've swapped the aikido mat for more familiar ground - the beating heart of the Lexus plant, and the sights and sounds that never fail to excite. Here, they are blended with a fixation on detail that has made Kyushu the world's highest-performing manufacturing facility. I'm peering politely over the shoulder of a 'Takumi' craftsman as he meticulously examines the stitching on the UX's leather upholstery. Just like the master's 'gi', the impression of strength and artistry is both tactile and visual, with its unique perforations incorporating curved lines and gradations. Alongside durability, it gives the occupant a reassuring sense of grip.

Coming off the line, the end product is beautiful to behold, from its glistening front signature grille to that sumptuously sculptured cabin. For many admirers that will suffice, but this morning I'm feeling quite privileged. It's as if my journey has revealed the hidden secrets of the new Lexus UX, and I'm itching to recount them to colleagues and friends when I get to test it back home. A pleasing thought for the long flight ahead.



02



03

01 Lexus Kyushu factory location
02 Dashboard grain inspired by sliding doors
03 Lexus 'Takumi' craftspeople oversee 'sashiko' stitching



01

- 01 Perfect for the city, the UX offers the widest field of vision for this kind of car
- 02 Remote-touch interface allows for quick menu searching and selection with the glide of a finger.
- 03 The tailgate closes smoothly at the touch of a button and features an auto-lock function available on the Premium Plus Pack

"The UX represents a completely new genre of SUV, built for modern adventurers on a journey to explore new horizons. People who prefer an imaginative yet refined lifestyle."

UX CHIEF ENGINEER
CHIKA KAKO

View Offers



Build Your UX



Find a Centre



Book a Test Drive



UX

The UX is powered by Lexus Self-Charging Hybrid that features a highly efficient new 2.0-litre four-cylinder petrol engine. The UX delivers astonishingly smooth performance and low CO₂ emissions starting from 120g/km and a fuel consumption range of 50.4 - 53.2 mpg* (E-FOUR 47.0 - 47.0).



F SPORT Grade with F SPORT White Metallic Paint

01. FOURTH GENERATION LEXUS SELF-CHARGING HYBRID

Offering class-leading fuel efficiency combined with a highly responsive driving experience, the UX features a fourth generation Lexus Self-Charging Hybrid, producing 184 DIN hp of power and a 0-62 mph time of 8.5 seconds (8.7 E-FOUR). At the heart of the UX's potent blend of petrol and electric power is the UX's Power Control Unit, which automatically delivers the most efficient mix of petrol and electric power.

02. 2.0-LITRE PETROL ENGINE

The UX's 2.0-litre petrol engine is one of the most efficient engines ever built by Lexus. Advanced features include laser-cut intake valve seats, a high compression ratio (14:1) and Lexus D4-S fuel injection combining direct and secondary port injectors. In addition, while exhaust heat recirculation enables quick engine warm-up, Variable Valve Timing-intelligent Electric enhances drivability and at the same time reduces emissions.

03. HYBRID AUTOMATIC TRANSMISSION

This next-generation hybrid automatic transmission connects the 2.0-litre petrol engine to two electric motor/generators and boasts 25% less internal friction than previous Lexus systems.

04. HYBRID BATTERY

The new nickel-metal hydride battery and cooling system are located below the UX's rear seat, while also contributing to the vehicle's low centre of gravity. As a self-charging hybrid it never needs to be plugged in.

05. E-FOUR

The UX Hybrid is available with optional E-FOUR electric All-Wheel Drive. The E-FOUR system uses a separate, dedicated electric motor/generator on the rear axle. Seamless power distribution between the front and rear axles makes for more stable driving - even on uphill slopes or snow-covered roads - but with lower fuel consumption than conventional all-wheel drive systems.



* Figures provided are for all front-wheel drive models.

EXPERIENCE LEXUS SELF-CHARGING HYBRID

**START UP, DRIVING OFF**

When starting off and at lower speeds, the powerful front electric motor (and extra rear electric motor on All-Wheel Drive models) swiftly propels the UX Hybrid, with electric power supplied by the hybrid battery. At this point the vehicle is almost silent, uses no petrol and produces zero emissions.

NORMAL DRIVING CONDITIONS

At higher speeds, the ultra-smooth petrol engine cuts in quietly while still receiving assistance from the electric motor(s) when required. Through the near-perfect distribution of its petrol and electric power sources, the UX provides extraordinary driving enjoyment, together with low emissions and fuel consumption.

FULL THROTTLE ACCELERATION

During forceful acceleration, the power of the electric motor(s) instantaneously supplements the 2.0-litre petrol engine. Together they deliver a potent surge of torque, providing fast linear acceleration precisely when needed.

DECELERATION, STOPPING, REGENERATIVE BRAKING

When decelerating or coming to a halt, the petrol engine turns off, cutting emissions to zero. On braking, or when your foot is taken off the accelerator, regenerative braking harnesses the kinetic energy. Together with power generated during normal driving conditions, the UX converts this into electrical energy for storage in the hybrid battery, removing the need for a Lexus Self-Charging Hybrid to be plugged in.

GRADE LINE-UP

UX

Standard Specification:

- 17" Alloy Wheels with Tyre Repair Kit
- Lexus Safety System + (2nd Gen)
- E-Call
- Bi-LED Headlights with Headlight Cleaner
- LED Front Fog Lights
- Premium Fabric Seats
- Lexus Link Connected Services
- 6 Speaker Audio with USB, CD, DAB and Bluetooth
- Apple CarPlay® and Android Auto®
- 7" Multimedia Display with 4 Drive Modes
- Rear View Camera
- 6-way Manual Front Seat Adjustments
- Dual Zone Automatic Air Conditioning with Nano-E sensor

PREMIUM PACK

- 18" Alloy Wheels with Run Flat Tyres
- Privacy Glass
- Front and Rear Parking Sensors
- Auto-dimming Rear View Mirror
- Heated Front Seats
- Heated Steering Wheel

PREMIUM PLUS PACK

- Includes Premium Pack
- Lexus Navigation
- LED Cornering Lights
- Smooth Leather Seats
- Japanese 'Washi' Paper-inspired Instrument Panel
- Smart Keyless Entry
- Power Back Door
- Illuminated Entry

LEXUS DRIVER ASSIST

In addition to Premium or Premium Plus Pack:

- Blind Spot Monitor (BSM)
- Rear Cross Traffic Alert and Auto Brake (RCTAB)
- Front and Rear Intelligent Parking Sensors

TECH & SAFETY PACK

In addition to Premium or Premium Plus Pack:

- Lexus Driver Assist
- Head-Up Display
- Wireless Charger
- 3-Eye LED Headlights with Adaptive High Beam System (AHS)
- Lexus Navigation

TECH & SOUND PACK

In addition to Premium Plus Pack:

- 13-Speaker Mark Levinson® Premium Surround Sound System
- 8-Way Power Front Seats
- Driver 2-Way Lumbar Support
- Power Adjustable Steering Wheel
- Head-Up Display
- Wireless Charger

PREMIUM PACK PRO

Includes Premium Plus Pack

- Blind Spot Monitor (BSM)
- Rear Cross Traffic Alert and Auto Brake (RCTAB)
- Head-Up Display (HUD)
- 3-Eye LED Headlights with Adaptive High Beam System (AHS)
- 13-Speaker Mark Levinson® Premium Surround Sound System
- Power Adjustable Steering Wheel
- 8-Way Electrically Adjustable Front Seats
- 2-Way Power Driver Lumbar Support
- Wireless Charger
- Sunroof

F SPORT

In addition to UX grade:

- Premium Pack
- 18" F SPORT Alloy Wheels with Run Flat Tyres
- F SPORT Exclusive Mesh Grille and Exterior Badging
- LED Fog Lights
- LED Cornering Lights
- F SPORT Tuned Suspension and Rear Performance Dampers
- F SPORT Fabric Tahara Upholstery
- F SPORT Aluminium Sports Pedals and Scuff Plates
- 8" Information Display Screen with LFA-inspired Moveable Meter Ring
- 8-Way Power and Heated Front Seats
- F SPORT Heated Steering Wheel with Paddle Shifters
- Driver 2-Way Lumbar Support
- Active Sound Control (ASC)
- Front and Rear Parking Sensors
- Privacy Glass
- Auto-dimming Rear View Mirror

PREMIUM PLUS PACK

- F SPORT Smooth Leather Seats
- Smart Keyless Entry
- Power Back Door
- Illuminated Entry
- 10.3" Lexus Navigation with 8 Speaker Audio and DVD
- Power Adjustable Steering Wheel

LEXUS DRIVER ASSIST

In addition to Premium or Premium Plus Pack:

- Blind Spot Monitor (BSM)
- Rear Cross Traffic Alert and Auto Brake (RCTAB)
- Front and Rear Intelligent Parking Sensors

TECH & SAFETY PACK

In addition Premium or Premium Plus Pack

- Lexus Driver Assist
- Head-Up Display
- Wireless Charger
- 3-Eye LED Headlights with Adaptive High Beam System
- Adaptive Variable Suspension
- Sport+ Driving Mode
- Lexus Navigation

TAKUMI PACK

- Premium Plus Pack
- Tech & Safety Pack
- Door Mirrors: Auto-folding with Reverse Tilt and Memory Functions
- 360° Panoramic View Camera
- 13-Speaker Mark Levinson® Premium Surround Sound System
- Ventilated Front Seats
- Memory Function for Driver Seat
- Sunroof

TAKUMI

In addition to UX grade:

- 18" Alloy Wheels with Run Flat Tyres
- 3-Eye LED Headlights with Adaptive Highbeam System
- Door Mirrors: Auto-folding with Reverse Tilt and Memory Functions
- Blind Spot Monitor
- Rear Cross Traffic Alert and Auto Brake
- Front and Rear Intelligent Parking Sensors
- Smart Keyless Entry
- LED Illuminated Vent Controls
- Power Back Door
- Head-Up Display
- Smooth Leather Upholstery
- Japanese 'Washi' Paper-inspired Instrument Panel
- Heated Front Seats
- 8-Way Power and Ventilated Front Seats
- Driver 2-Way Lumbar Support
- Memory Function for Drivers Seat and Heated Steering Wheel
- Power Adjustable Steering Wheel
- 13-Speaker Mark Levinson® Premium Surround Sound System
- 10.3" Lexus Navigation
- 360° Panoramic View Camera
- Sunroof

OPTIONS

Grade	Optional packs	OPTIONS		
		Lexus Navigation	Sunroof	E-FOUR
UX	Premium Pack	○	—	—
	Premium Pack and Tech & Safety Pack	○	—	—
	Premium Plus Pack	■	○	○
	Premium Plus Pack and Tech & Safety Pack	■	○	○
	Premium Plus Pack and Tech & Sound Pack	■	○	○
	Premium Pack Pro	■	■	○
F SPORT	Premium Plus Pack	○	—	—
	Tech & Safety Pack	■	○	—
	Premium Plus Pack and Tech & Safety Pack	■	○	○
	Takumi Pack	■	■	○
TAKUMI		■	○	

- Available as standard.
- Available as an option.
- Not available.



For full list of specification refer to pages 50-52.

View Offers

Build Your UX

Find a Centre

Book a Test Drive

Book a Test Drive

Book a Test Drive

Book a Test Drive

Book a Test Drive

Book a Test Drive

Book a Test Drive

Book a Test Drive

Book a Test Drive

Book a Test Drive

Book a Test Drive

Book a Test Drive

Book a Test Drive

Book a Test Drive

Book a Test Drive

Book a Test Drive

Book a Test Drive



01

01. 17" AERO VENTILATING WHEELS

Finished in metallic silver, these aero ventilating wheels feature flaps on each side of the spokes and are a world first for Lexus. The flap shape is based on the 'Gurney Flap', which is installed on the rear wing of race cars to regulate the airflow and create vortices that increase downforce. This innovative new wheel design enables more confident driving by providing stable braking performance, increasing cooling efficiency and reducing turbulence along the sides of the car.



02

02. 18" ALLOY WHEELS

These two-tone wheels combine a machined finish with a black metallic coating to give a sporty and luxurious look. Available on the UX grade when any optional pack selected.

03. BI-LED HEADLIGHTS

Featuring a single-projector bi-beam LED unit and L-shaped Daytime Running Lights, these headlights create a resolute expression.



03

04. 3-EYE LED HEADLIGHTS*

These headlights feature compact triple-projector LED units and L-shaped Daytime Running Lights that display a Lexus signature arrowhead. Additionally, multi-weather lights help maintain a safe field of view in foggy driving conditions.



04

05. LED CORNERING LIGHTS*

The UX's LED cornering lights provide extra illumination in the area close to the car when turning left or right.



05

* Available on selected grades and packs.

06. DAYTIME RUNNING LIGHTS

Arrowhead-shaped Daytime Running Lights are installed above the headlights. They display the Lexus L-shaped signature motif that creates a sense of continuation with the vehicle's exterior, while vertical illumination lines express a sense of depth, creating a unique illumination design.



06

07. AERO STABILISING REAR LIGHT

The rear combination light on the new UX has an advanced design that is not only eye-catching but also aerodynamically efficient. Fins are integrated into the light to reduce air pressure changes by 16%, contributing to excellent rear stability during cornering as well as in side winds. For a distinctive look, a continuous single line of light is formed by 120 LEDs, tapering gently towards the centre and measuring just 3mm at the narrowest point.



07

08. SUNROOF*

An electric, tilt and slide, glass sunroof adds a feeling of freedom, spaciousness and light to the UX cabin.

09. ROOF RAILS

Roof rails made from solid aluminium create an appealing shape that runs smoothly and seamlessly along the UX roofline.

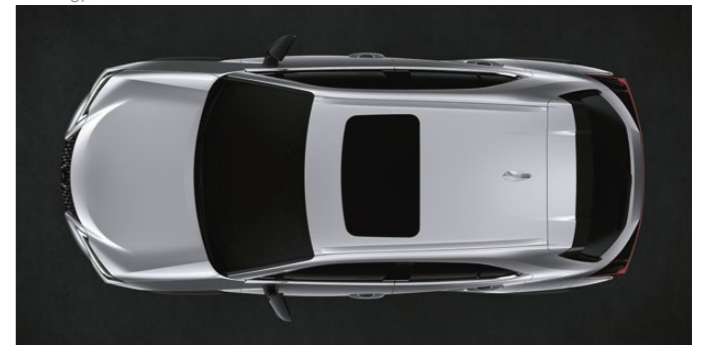

08



09

View Offers



Build Your UX



Find a Centre



Book a Test Drive





01



02



03

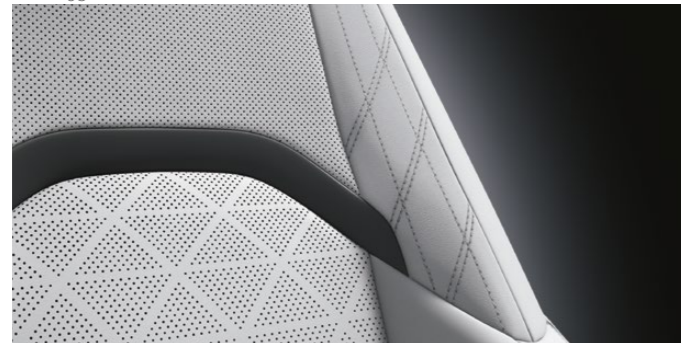

04



05

01. DRIVER-FOCUSED COCKPIT

To create a sense of seamless continuity, our designers sought to eliminate the boundary between the exterior and interior. The effect gives the driver an excellent field of vision with a clear sense of the car's dimensions. This concept is most evident from the driver's seat, where the upper section of the instrument panel appears to extend out beyond the windscreen. The human-centred approach benefits the design of the UX's interior, with a 'seat-in-control' concept that focuses major controls around the driver's side of the cabin.

02. S-FLOW CLIMATE CONTROL / CLIMATE CONCIERGE

S-Flow climate control intelligently manages the interior climate according to ambient conditions, ensuring excellent comfort and fuel economy. It can, for example, detect if seats are occupied, and regulate the climate accordingly. The system also discharges mildly acidic nanoe[®] ions from the central air conditioner register on the driver's side of the cabin, helping to fill the cabin with fresh air and creating an atmosphere that gently moisturises your skin and hair.

03. STEERING WHEEL

Offering an amazing level of luxury for this class of vehicle, the 3-spoke steering wheel was adopted from our LS flagship. The grip profile of this steering wheel was crafted and perfected by recording the pressure on the palms of our 'Takumi' master driver during numerous test drives. For a luxurious experience, the entire circumference of the wheel is wrapped in genuine leather. It is available with heating for colder mornings, while integrated switches control audio, telephone, multi-information display, Dynamic Radar Cruise Control and Lane Tracing Assist.

04. LEATHER SEATS / 'SASHIKO' QUILTING*

In a theme also inherited from our LS flagship, the UX seatbacks feature an upper/lower two-part construction symbolising the 'seat-in-control' concept. The smooth leather upholstery is inspired by 'sashiko', a traditional Japanese quilting technique, which is also used in the making of martial arts uniforms. The quilted leather is decorated with new perforation patterns that form mathematical curves and gradations in perfect alignment, enhancing the appearance of the seats.

05. FRONT SEAT ADJUSTMENT

The new UX provides an ergonomic driving position that reduces fatigue and provides an excellent feeling of being enveloped. Up to eight seat adjustments allow many driving positions that are suitable for a wide range of drivers.

06. LUMBAR SUPPORT

For superb comfort on long journeys, driver electric 2 way lumbar support adjustment is available on selected grades and packs.

07. 'WASHI' INTERIOR TRIM*

The UX's sweeping instrument panel covers a large area, connecting the driver and passenger sides of the car. This provides an opportunity to accentuate the atmosphere of the cabin using high-quality materials, with a choice of two grain patterns and four colours. The UX is the first Lexus model to offer cabin trim inspired by the grain of a paper, known as 'washi', which is used in traditional Japanese sliding doors.

08. WIRELESS AIR VENT ILLUMINATION

Each air vent uses a single knob to control airflow direction and volume. Takumi grade models feature illuminated vent controls with a distinctive LED light source that is wirelessly powered using induction.

09. HEATED AND VENTILATED SEATS*

Seat heaters are available for the driver and front passenger.



06



07



08



09

* Available on selected grades and packs.

View Offers



Build Your UX



Find a Centre



Book a Test Drive





01

01. LEXUS PREMIUM SOUND SYSTEM

The new UX is available with either a six- or eight-speaker Lexus Premium Sound System. Creating the sensation of a live stage right in front of the listener, sound is efficiently delivered both directly from the speakers and reflected off the glass. To provide clear and vibrant vocal reproduction with minimal distortion, the Panasonic® speaker diaphragms are made from a resin containing bamboo charcoal and opal plant fibres, which enhances their recyclability.

02. MARK LEVINSON® PREMIUM AUDIO*

The UX's 13-speaker Mark Levinson® Premium Surround Sound system produces world-class sound. The ideal design was pursued for every electrical component in the system to deliver a total harmonic distortion (THD, an indicator of signal distortion) of 0.1% or less.#

03. LEXUS NAVIGATION

7" multimedia display as standard can be upgraded to a 10.3" display.*

04. OPTITRON INSTRUMENTATION

The UX cockpit features Optitron instrumentation with a 7-inch information display screen. This shows a range of information with great clarity, as well as elegant animations when you enter and start up the car.

05. HEAD-UP DISPLAY*

Vehicle data is projected in colour directly onto the windscreen. The Head-Up Display, measuring 10.2-inch, lets you check data such as navigation commands, audio settings or safety features without taking your eyes off the road ahead.

06. REMOTE TOUCH INTERFACE

The central display screen is controlled by Touch Pad or voice commands. The Touch Pad interface has been designed to give you the intuitive feel of a smartphone, using operations such as double tapping and flicking.

07. WIRELESS CHARGER*

A wireless charger located on the centre console enables a compatible device or smartphone to be charged by simply placing it on the charging pad, eliminating the need to connect a charging cable.

08. LEXUS LINK - CONNECTED SERVICES

Connecting to the new Lexus Link app transforms your UX into a connected car. Lexus Link gives you seamless access to connected services like:

- Driving Analytics: Tracks your journeys, driving style and business trips
- Find My Car: Locates your Lexus and guides you back to it through your preferred navigation app.
- Safety Plan: Sends a text message to the contact of your choice in the event of an accident.
- Service and Maintenance: Displays a reminder to help you manage the care of your UX
- Share to Car: Lets you plan a route on another device and send it to your Lexus, while 'Last Mile Guidance' guides you on foot to your final destination once you are parked

09. SMARTPHONE INTEGRATION

With Apple CarPlay® and Android Auto®, the UX allows you to easily display and access some of your smartphone's compatible apps. For more details on handset compatibility and features, please visit the official Apple CarPlay® or Android Auto® website.

* Available on selected grades and packs.



02



03



04



05



06



07

01. HIGH RIGIDITY PLATFORM

The UX features a new platform which is the foundation for the car's excellent dynamic performance. Its development focused on giving nimble and instant response to the driver's inputs, while communicating a sense of stability and safety. The platform allows for an increase in rigidity, including a high-tensile and ring structure around the rear door and tailgate openings. Highly rigid adhesives and laser screw welding have been used in key locations, greatly enhancing overall stiffness.

02. LOW CENTRE OF GRAVITY

Thanks to the new platform, the UX has the lowest centre of gravity of any vehicle in its class. This characteristic, central to the car's dynamic performance, is complemented by weight-saving measures in the body construction, including lightweight aluminium for the doors, wings and bonnet, as well as a resin material for the tailgate.

03. ADVANCED AERODYNAMICS

The new UX boasts excellent aerodynamics including a near-flush underbody, which not only contributes to good fuel economy, but also reduces wind noise and turbulence. Other aerodynamic breakthroughs include a one-piece rear light with integrated fins to keep the rear of the car stable when turning and driving in crosswinds. Additionally, the UX wheel arch mouldings have flat sides and a stepped top section which generates airflow to reduce roll and keep the car stable when cornering, changing lanes or being driven in a straight line.

04. SUSPENSION

MacPherson strut front suspension and a double wishbone arrangement at the rear have been designed and tuned to promote ride comfort and sharp response. Special attention has been paid to shock absorber performance and the quality of the damper oil, oil seals and friction control.

05. ELECTRIC POWER STEERING

An Electric Power Steering system with a more compact and rigid column assist has been adopted with a larger diameter column shaft. This supports handling with crisp, immediate response to driver inputs and enhanced steering feel.

06. DRIVE MODE SELECT

The LC inspired Drive Mode Select switch has been placed beside the meter hood bezel so that it can be operated without requiring a significant deviation from your line of sight or change in your driving position. Eco, Normal and Sport modes are standard on all grades, and the Sport+ mode is available as an addition on selected grades and packs.



01

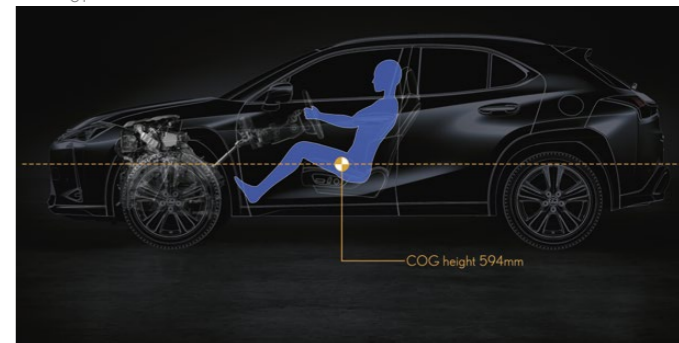

02



03



04



04



05



06



01

01. LEXUS SAFETY SYSTEM +

All UX grades come as standard with the very latest Lexus Safety System +

Lexus Safety System + includes:

- Pre-Collision System with pedestrian detection
- Dynamic Radar Cruise Control
- Road Sign Assist
- Lane Tracing Assist
- Automatic High Beam or optional Adaptive High-Beam on selected grades and packs.



02

02. PRE-COLLISION SYSTEM

The Pre-Collision System on the new UX can now detect pedestrians at night and bicycles during daytime. To achieve this, the camera sensitivity and dynamic range have been enhanced to help reduce accidents in the dark, for example, when a pedestrian in front of an oncoming vehicle is difficult to see due to the vehicle's lights. Furthermore, the millimetre-wave radar detection area angle has been widened, enabling bicycles to be detected. If the system judges that the possibility of a collision is high, the brakes are automatically applied to support collision avoidance, or reduce damage in the event of a collision.

03. DYNAMIC RADAR CRUISE CONTROL

The system uses the millimetre-wave radar sensor and a camera to detect the vehicle in front and provide control to maintain an appropriate distance. If the vehicle in front comes to a halt, the system will stop the UX. When the vehicle moves off again, the UX will start off and continue following. This system reduces the burden on the driver in situations requiring frequent starting and stopping.



03

04. ROAD SIGN ASSIST

The Road Sign Assist (RSA) system on the new UX recognises traffic signs and provides information to the driver via the multi-information display. When linked to Dynamic Radar Cruise Control, the car's speed setting can be quickly reset in accordance with the speed limit recognised by RSA. All it takes is the touch of a button. RSA identifies all important road signs and warnings, including electroluminescent and flashing signs.

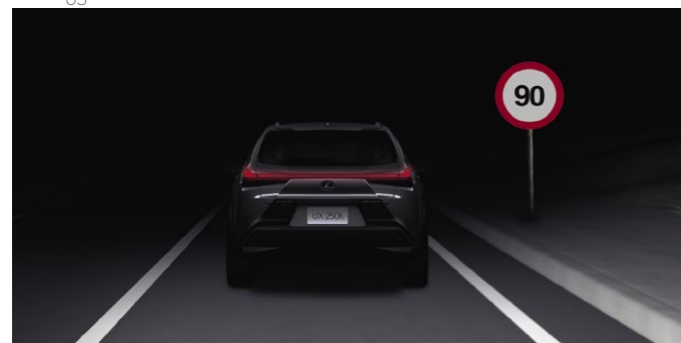

04

05. LANE TRACING ASSIST

Lane Tracing Assist helps the driver to keep the UX in the centre of the lane. It is also capable of providing assistance when driving around bends with a tighter radius than the previous system. If the system determines that there is a possibility of the UX departing from the lane, it will switch to departure prevention control, providing support for returning the car to the centre of the lane.



05

Under no circumstances should Lexus Safety System + be used to replace your driving skills at the wheel. Please read the instructions very carefully before operating the system and remember the driver is always responsible for safety. Details of specifications and equipment are subject to change to suit local conditions and requirements. Please enquire at your local Lexus Authorised Retailer.

06. ADAPTIVE HIGH BEAM SYSTEM*

An adjustable LED Adaptive High-beam System prevents the UX from dazzling other road users. Independent LED chips in the headlight are enabled/disabled for precise control of the illuminated and non-illuminated areas.



06

07. TYRE PRESSURE WARNING SYSTEM

Receiving data from a sensor installed in each tyre, the multi-information display shows tyre pressure data and warns accordingly should pressure drop in one of them. The system can reduce the risk of a puncture, while helping to improve fuel economy and tyre life.



07

08

08. INTELLIGENT PARKING SENSORS*

Giving great confidence when parking at close quarters, Parking Support Alert warns of an impending collision using clearance sonar, with a buzzer and a visual display in the centre display and relevant door mirrors. If required, it can apply Drive Force Control and Brake Control to avoid a collision.

09. REAR CROSS TRAFFIC ALERT AND AUTO BRAKE*

The Rear Cross Traffic Alert function operates when the car is reversing. It detects obstacles around the car and vehicles approaching the area behind the car. When necessary, the system alerts you with a buzzer and a visual display in the centre display and relevant door mirrors. If required, it can apply Drive Force Control and Brake Control to avoid a collision.



09

10. BLIND SPOT MONITOR*

Radar devices mounted in the rear bumper detect vehicles in adjacent lanes that are not visible in the door mirrors. If a vehicle enters the blind spot, a warning signal appears in the relevant door mirror.

11. PANORAMIC VIEW MONITOR**

The Lexus parking assist monitor** helps you reverse into parking spaces. On the central display it shows a video image of the space into which you are reversing, and overlays guidelines to facilitate you steering the car. For easier driving in confined spaces, the Panoramic View Monitor provides a near-360° view around the entire car. It also creates a virtual 3D picture of your UX, with on-screen guides to assist close-quarter manoeuvring in the city.



10

11

12. AIRBAGS

Extending its safety performance even further, the new UX has a comprehensive shield of eight airbags as standard. These include driver and front passenger airbags and knee airbags, side airbags front and rear, and curtain airbags covering all side windows.



12

* Available on selected grades and packs.
 ** People and obstacles that show in the monitor differ from the actual position and distance. Do not rely completely on the monitor and, for safety, make sure you check around the vehicle with your own eyes when driving.

View Offers



Build Your UX



Find a Centre



Book a Test Drive





01

01. 18" F SPORT ALLOY WHEELS

Inspired by those on the LC coupé and LS flagship, the F SPORT is fitted with exclusive 18" 5-twin-spoke high-rigidity alloy wheels with a dark metallic coating.



02

02. F SPORT STEERING WHEEL

Featuring the F SPORT logo, the F SPORT's steering wheel conveys a special kind of connection to the driver. Paddle shifters allow swift and precise gear changes without taking your hands off the wheel. Finished in perforated leather, the F SPORT gearshift design matches the steering wheel. The steering wheel is also heated for extra comfort while driving.



03

03. F SPORT INSTRUMENTS

This F SPORT central meter features an innovative 8-inch information display screen and a design inherited from the iconic Lexus LFA supercar. The display has a tachometer needle and digital speed indicator, as seen on Lexus F marque cars.



04

04. F SPORT CLOCK

An exclusive F SPORT clock with a carbon look and L-motif face design is fitted to the F SPORT.



05

05. F SPORT SEATS

Enjoy figure-hugging F SPORT leather seats similar to those on the LC sports coupé, with 8-way electric adjustment and driver 2-way electric lumbar support. All stitching on the seats, steering wheel, instrument panel and gearshift is overseen by our 'Takumi' master craftspeople.



06

06. F SPORT SIGNATURE GRILLE

The exclusive F SPORT signature grille and front bumper styling sets the F SPORT apart. Finished in jet black, the grille's complex mesh is inspired by that of the LS F SPORT and required months of intensive computer modelling to design.



07

07. F SPORT REAR STYLING

A centre moulding and rear reflector bezel featuring jet black plating underline the SUV's F SPORT looks.

08. F SPORT SCUFF PLATES & DRILLED SPORT PEDALS

Providing enhanced protection, the durable F SPORT scuff plates are finished with a brushed aluminium look and are inscribed with the Lexus logo. Drilled aluminium pedals offer excellent grip characteristics and reflect the motorsport design heritage of the F SPORT.



08

09. SPORT S+ MODE*

Sport S+ mode on the F SPORT models adjusts suspension, steering and throttle response, making for a sportier driving experience.

10. ADAPTIVE VARIABLE SUSPENSION*

For an even higher level of dynamic performance, the UX F SPORT is available with an Adaptive Variable Suspension, similar to that found in the LC coupé. This has adjustable dampers at each wheel with 650 levels of damping force to provide ultimate control on any road surface.



09

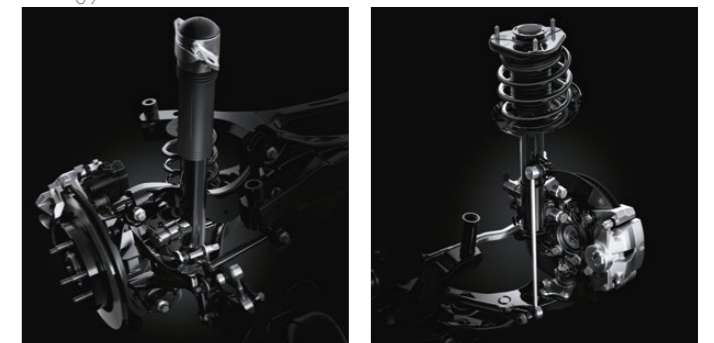

10

* Available on selected grades and packs.



STYLE PACK

The new Lexus UX is an SUV that challenges everything that went before. The Style Pack, with these stylish aerodynamic skirts emphasise its dynamic sporty appearance.

Front skirt: this skirt integrates into the lower edge of the bumper to give your UX a powerful lower profile look.

Side skirt: extend the styling of your UX's side sills to maximise its sporty look.

Rear skirt: the wrap-around styling puts a dynamic finishing touch to your UX's sporty appearance.



ADVENTURE PROTECTION PACK

Wherever you go exploring, the adventure protection pack helps protect your UX from dirt, mud and sand. This pack features a combination of front and rear mudflaps, boot liner, rubber floor mats and boot cargo net.

Image shown is the boot liner.

01. VERTICAL DETACHABLE TOWING HOOK

Attach the lockable tow ball when you need it, remove it when you don't to boost the versatility of your UX. Towing capacity of UX: 750kg.

02. ILLUMINATED SCUFF PLATES*

Style and sophistication shine out from these illuminated scuff plates and give your UX an extra touch of class.

03. ROOF ACCESSORIES

Cross bars: these cross bars lock into your UX's roof rails and create a secure and stable base for a wide variety of special attachments. **Roof box (luggage box, Thule touring 600 glossy black):** this streamlined roof box gives your UX an extra 300 litres of carrying capacity. It opens from both sides and has a central locking point. Roof bike holders are also available for your UX.

04. 18" ALLOY WHEEL - GLOSSY BLACK MACHINED

The glossy black machined finish and high performance 10-spoke design create an unmistakable look of urban sophistication.

05. DOOR HANDLE PROTECTION FILM**

Shaped to fit neatly into the door handle's concave grip area. The film is virtually invisible, yet provides tough protection against scratching by gloves, rings and keys.

06. FRONT AND REAR DASH CAM

With its full 1080p HD camera, the front and rear dash cam are here to provide you with an extra peace of mind when you drive.

* Expected to be available in Q3 2019. Please contact your local centre for more information.
** Image is for reference only.



03



04



01



05



02



06

DEVELOPING A NEW LEXUS PAINT COLOUR IS BOTH COMPLEX AND TIME-CONSUMING



Lexus designers never use off-the-shelf colours, preferring instead to develop their own from scratch, a process that can take up to two years. The Lexus paint palette totals some 30 different colours including metallic finishes like Satin Silver and Sonic Titanium.

There are no shortcuts to creating a new Lexus colour: a designer's decision comes only after going through hundreds of samples. "When developing a new colour I see so many shades of paint that I sometimes can't see straight at the end of the day," says Megumi Suzuki, one of our most experienced colour designers. To do her job, it takes a grasp of chromogenics and a keen eye.

"Every time I meet someone or walk into a shop or go to someone's house, I check out colours and materials," she says. "There are a lot of people like me in our division."

Even after a colour has been decided upon, there's plenty to do. At various stages during development, Suzuki had to enlist a small army of experts: lab technicians who mix the paint, clay sculptors, engineers and the assembly-line paint shop crew who would give each car a flawless, uniform coat. Every few weeks Kansai Paint (a Lexus paint supplier) produces a new batch and Lexus designers give the samples a thorough look-over, bending the test panels to mimic the contours of a car. All are scrutinised indoors and outdoors, under floodlights, in sunlight, shade and overcast conditions, and at different times of the day and months of the year.

Selecting the final colour is not easy. A colour that is dazzling on a summer morning can appear sickly in the shade or under showroom lights. Designers also have to contend with the vagaries of their own preferences. "The odd thing about colour is that your perception of it can change depending on the season, how you feel that day and the trends you're seeing," says Suzuki.

SOLID COLOURS

FUJI RED | 3T2



VELVET BLACK | 212



METALLIC COLOURS

MERCURY GREY | 1H9

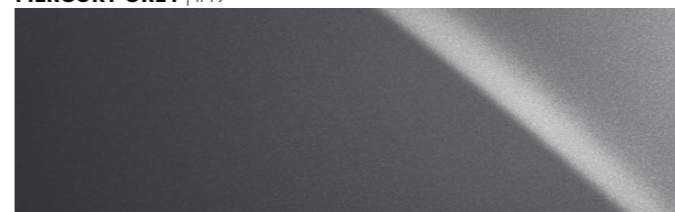

SATIN SILVER | 1J4²

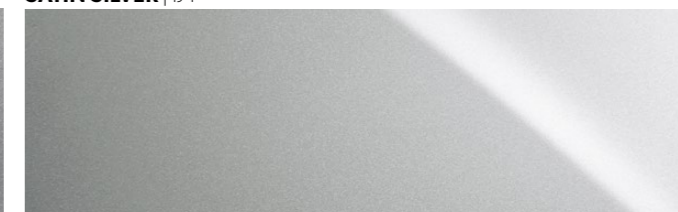

GRAPHITE BLACK | 223

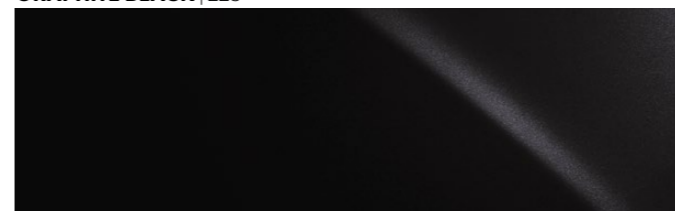

TERRANE KHAKI | 6X4



CELESTIAL BLUE | 8Y6²



F SPORT WHITE | 083¹

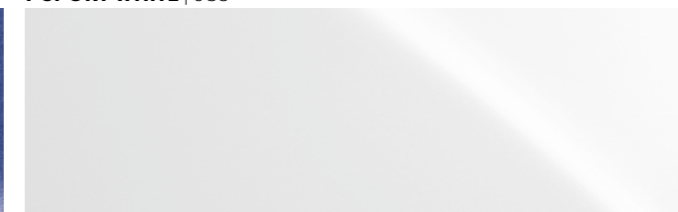

SPECIAL METALLIC COLOURS

SONIC TITANIUM | 1J7

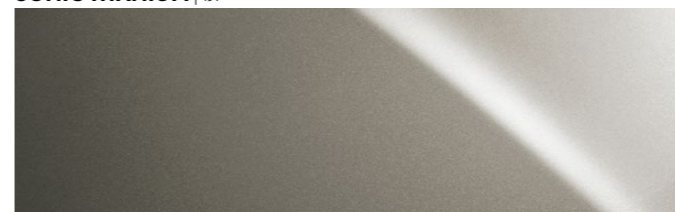

SONIC WHITE | 085²



AZURE BLUE | 8X1¹



BLAZING CARNELIAN | 4Y1¹

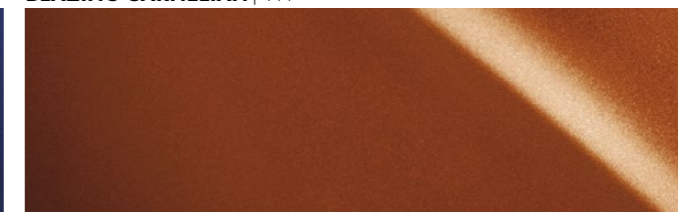

¹Exclusive to F SPORT. ²Not available on F SPORT. Please note: due to printing variances, actual paintwork colours may vary slightly from those illustrated.

PREMIUM FABRIC



Black Cobalt

F SPORT FABRIC / TAHARA TRIM



Black and Red Flare Red and Black

SMOOTH LEATHER* with Japanese washi paper inspired instrument panel



Black White Ash Ochre Rich Cream Cobalt

F SPORT LEATHER

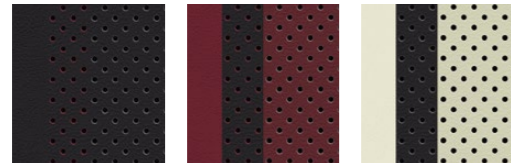

Black with Red Accent** Flare Red and Black F White and Black



01



02

* Available with the Premium Plus Pack and standard on Takumi grade. Cobalt interior is not available on Takumi grade.
 ** The red accent is on the central panel of the seats in addition to red stitching.

01 Black Interior
 02 Cobalt interior.



01

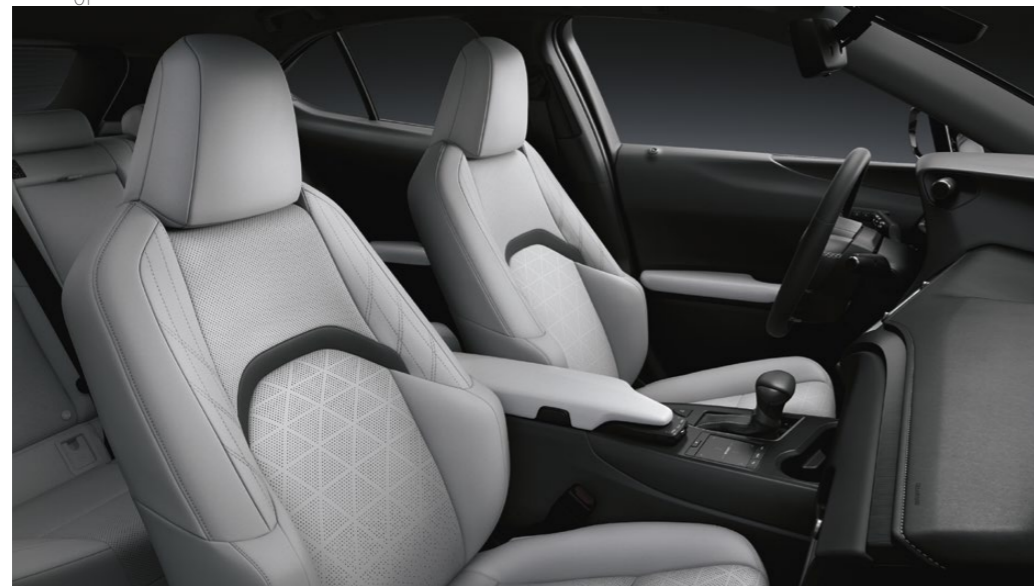

02



03

01 Rich Cream Interior
02 White Ash Interior
03 Ochre Interior



01



02



03



04

01 Black and Red Fabric Tahara*
F SPORT Interior
02 Flare Red and Black F SPORT Interior
03 Black Smooth Leather with red accent
F SPORT Interior**
04 F White and Black F SPORT Interior
*Man-Made Leather
**The red accent is on the central panel
of the seats in addition to red stitching.

ACTIVE SAFETY AND DRIVING DYNAMICS	UX	F SPORT	TAKUMI
Adaptive High-beam System (AHS)	□ ^{4,6}	□ ^{4,7}	■
Adaptive Variable Suspension (AVS)	-	□ ^{4,7}	-
Anti-lock Braking System (ABS)	■	■	■
Automatic High Beam (AHB)	■	■	-
Blind Spot Monitor (BSM)	□ ^{3,4,6}	□ ^{3,4,7}	■
Drive Mode Select, Eco / Normal / Sport	■	■	■
Drive Mode Select, Eco / Normal / Custom / Sport S / Sport S+	-	□ ^{4,7}	-
Dynamic Radar Cruise Control (DRCC)	■	■	■
Electronically Controlled Braking-Regeneration (ECB-R)	■	■	■
Emergency Response System (eCall)	■	■	■
EV (Electric Vehicle) mode	■	■	■
Hill-start Assist Control (HAC)	■	■	■
Parking Assist Sensors, Front and Rear with Intelligent Clearance Sonar	□ ^{3,4}	□ ^{3,4,7}	■
Lane Tracing Assist (LTA)	■	■	■
Lexus Safety System +	■	■	■
Parking assist sensors, front and rear	□ ^{1,2,6}	■	-
Pre-Collision System (PCS)	■	■	■
Rear Cross Traffic Alert and Braking (RCTAB)	□ ^{3,4,6}	□ ^{3,4,7}	■
Rear performance dampers	-	■	-
Road Sign Assist (RSA)	■	■	■
Traction Control (TRC)	■	■	■
Tyre Pressure Warning System (TPWS) with auto-location	■	■	■
Vehicle Stability Control (VSC)	■	■	■

WHEELS

17" alloy wheels, silver, 5-wide-spoke design, 215/60 R17 tyres with tyre repair kit	■	-	-
18" alloy wheels, F SPORT design, 225/50 R18 run-flat tyres	-	■	-
18" alloy wheels, machined finish, 5-wide-spoke design, 225/50 R18 run-flat tyres	□ ^{1,2,6}	-	■

EXTERIOR

Cornering lights, LED	□ ^{2,6}	■	■
Daytime running lights, LED	■	■	■
Door mirrors, electrically adjustable with memory, heated	-	□ ⁷	■
Door mirrors, electrically adjustable, heated	■	■	■
Auto-folding and tilt on reverse outer door mirrors	-	□ ⁷	■
F SPORT logos, front fenders	-	■	-
F-mesh signature grille	-	■	-
Front fog lights, LED	■	■	■
Headlight cleaners	■	■	■
Headlights, bi-beam LED	■	■	-
Headlights, triple LED	□ ^{4,6}	□ ^{4,7}	■
Privacy glass	□ ^{1,2,6}	■	■
Rain-sensing windscreen wipers	■	■	■
Rear combination lights, LED	■	■	■
Rear fog light, LED	■	■	■
Rear spoiler	■	■	■
Roof rails	■	■	■

- Available as standard.
- Available as an option.
- Available as part of a pack.
- Not available.
- ¹ Premium Pack
- ² Premium Plus Pack
- ³ Lexus Driver Assist
- ⁴ Tech & Safety Pack
- ⁵ Tech & Sound Pack
- ⁶ Premium Pack Pro
- ⁷ Takumi Pack

PASSIVE SAFETY	UX	F SPORT	TAKUMI
Airbag cut-off switch, front passenger	■	■	■
Airbags, driver and front passenger; head, side and knee / full-length curtain shield / rear side with roll over sensor	■	■	■
Audible and visual seatbelts reminder	■	■	■
ISOFIX attachment, outer rear seats	■	■	■
Seatbelt pre-tensioners, front seats	■	■	■
Seatbelt pre-tensioners, outer rear seats	■	■	■

SECURITY

Anti-theft system - horn	■	■	■
Anti-theft system - intrusion sensor / inclination sensor / siren	■	■	■
Auto door locking	■	■	■
Double door lock	■	■	■
Wireless door lock	■	■	■

AUDIO, COMMUNICATION & INFORMATION

Smartphone Integration - Apple CarPlay® and Android Auto®	■	■	■
Lexus Link Connected Services	■	■	■
Lexus Navigation	○ □ ^{2,4,6}	○ □ ^{2,4,7}	-
7" Multimedia Display Screen	■	■	-
10.3" Lexus Premium Navigation	-	□ ^{2,7}	■
8" LFA Inspired Information Display Screen with Moveable Meter Ring	-	■	-
6-speaker Panasonic® audio system	■	■	-
8-speaker Panasonic® audio system	-	□ ²	-
13-speaker Mark Levinson® Premium Surround Sound system	□ ^{5,6}	□ ⁷	■
Active Sound Control (ASC)	-	■	-
Analogue clock	■	■	■
Bluetooth® mobile phone and audio connectivity	■	■	■
Digital speedometer	■	■	■
Head-Up Display (HUD)	□ ^{4,5,6}	□ ^{4,7}	■
Panoramic View Monitor (PVM) with pedestrian alert	-	□ ⁷	■
Touch Pad operation for multimedia display	■	■	■
Wireless smartphone charger	□ ^{4,5,6}	□ ^{4,7}	■

- Available as standard.
- Available as an option.
- Available as part of a pack.
- Not available.
- ¹ Premium Pack
- ² Premium Plus Pack
- ³ Lexus Driver Assist
- ⁴ Tech & Safety Pack
- ⁵ Tech & Sound Pack
- ⁶ Premium Pack Pro
- ⁷ Takumi Pack

INTERIOR COMFORT & CONVENIENCE	UX	F SPORT	TAKUMI
3-spoke, leather trimmed steering wheel	■	-	■
3-spoke, leather trimmed heated steering wheel	□ ^{12,6}	-	■
3-spoke, perforated leather trimmed heated steering wheel with paddle shifters	-	■	-
Aluminium scuff plates with LEXUS inscription, front doors	-	■	■
Centre console, Gloss Black	■	-	-
Centre console, Hairline Metallic	-	■	■
Power adjustable steering wheel	□ ^{5,6}	□ ⁷	■
Electronic climate control, 2-zone with auto-recirculation	■	■	■
Electronic climate control, additionally with humidity sensor	■	■	■
Electronic climate control, additionally with nanoe [®] technology	■	■	■
Front seat lumbar support, electrically adjustable, 2-way (driver)	□ ^{5,6}	■	■
Front seats, electrically multi-adjustable	□ ^{5,6}	■	■
Front seats, memory function for driver	-	□	■
Front seats, F SPORT design	-	■	-
Front seats, heated	□ ^{12,6}	■	■
Front seats, manually adjustable	■	-	-
Front seats, ventilated	-	□ ⁷	■
Instrument panel upper, Tahara trim	■	■	■
Instrument panel upper, Japanese washi paper inspired	□ ^{2,6}	-	■
Keyless smart entry system	□ ^{2,6}	□ ^{2,7}	■
Leather trimmed gear stick	■	-	■
Perforated leather trimmed gear stick	-	■	-
Machined aluminium sports pedals	-	■	-
Paddle shift controls	-	■	-
Power back door	□ ^{2,6}	□ ^{2,7}	■
Rear-view mirror, auto-dimming	□ ^{12,6}	■	■
Rear-view mirror, manual dimming adjustment	■	■	-
Resin scuff plates, front and rear doors	■	-	-
Upholstery, F SPORT fabric / Tahara trim	-	■	-
Upholstery, F SPORT leather	-	□ ⁷	-
Upholstery, Premium fabric	■	-	-
Upholstery, Smooth leather	□ ^{2,6}	-	■
Wireless air-vent illumination	-	-	■

■ Available as standard.
 □ Available as an option.
 □ Available as part of a pack.
 - Not available.

□¹ Premium Pack
 □² Premium Plus Pack
 □³ Lexus Driver Assist
 □⁴ Tech & Safety Pack
 □⁵ Tech & Sound Pack
 □⁶ Premium Pack Pro
 □⁷ Takumi Pack

3 YEARS FREE LEXUS ROADSIDE ASSISTANCE

Whatever the situation, when you're driving your Lexus, we're just one call away with expert support at the roadside 24 hours a day, every day of the year.

Free for 3 years from initial purchase of new vehicle 24 hour a day, 365 days a year assistance anywhere in the UK.

Home Start

- One in four breakdowns happen at the home address. Home Start allows you to enjoy all the benefits of Lexus Roadside Assistance from your home address.

Personal assistance

- Lexus Roadside Assistance is designed to look after you - not just your vehicle. So even if you are a passenger in someone else's car you can still receive Lexus Roadside Assistance.

Replacement vehicle

- A replacement vehicle will be provided free of charge (excluding petrol and other consumables) for up to three days, provided we have taken your vehicle to

a Lexus Centre for repairs following a breakdown.

Hotel accommodation

- If a replacement vehicle is unavailable, we will arrange a hotel for you and your family for up to £150 per person to a maximum of £500, for one night.

Onward travel

- If a replacement vehicle is unavailable and you would like to make your own travel arrangements following a breakdown, we will reimburse the cost of this up to £150 per person, to a maximum of £500.

European travel

- If you travel across Europe your Roadside Assistance will travel with you, whether you are driving your Lexus or another car.

Medical assistance

- If the driver of the car is certified ill, we will take you and your passengers to any single destination in the UK.

Lost or broken keys

- If you lose or break your keys, Lexus Roadside Assistance will arrange for recovery of your vehicle to a local Lexus

Centre. You will be responsible, however, for the cost of replacement keys.

HYBRID BATTERY WARRANTY COVER AND HYBRID HEALTH CHECK (HHC)

A Hybrid Health Check is included in all services for hybrid vehicles, where a technician will test the entire hybrid system and provide a written report.

With each Hybrid Health Check, the customer will receive an extra 1 year or 10,000 mile (whichever comes sooner) hybrid battery warranty extension, until the vehicle is 15 years old.

An annual Hybrid Health Check is free of charge as part of any Lexus Service. If a service isn't due for a while, a standalone Hybrid Health Check is available for just £59 to offer the customer peace of mind.



TECHNICAL DATA

ENGINE	UX 250h (E-FOUR)
Capacity (cm ³)	1987
Cylinders / Valves	L4 / 16
Maximum power (DIN hp @ rpm)	152 @ 6000
Maximum power (kW @ rpm)	112 @ 6000
Maximum torque (Nm @ rpm)	190 @ 4400 - 5200
ELECTRIC MOTOR(S)	
Type	AC synchronous, permanent magnet (AC synchronous, permanent magnet / induction E-FOUR)
Maximum power (DIN hp) front / rear	109 / - (109 / 7 E-FOUR)
Maximum power (kW) front / rear	80 / - (80 / 5.3 E-FOUR)
Maximum torque (Nm) front / rear	202 / - (202 / 55 E-FOUR)
TRANSMISSION	
Type	Electronic-Continuously Variable Transmission
Drive	Front-Wheel Drive (E-FOUR)
TOTAL SYSTEM OUTPUT	
Total power (DIN hp)	184
Total power (kW)	135
PERFORMANCE	
Maximum speed mph (km/h)	110 (177)
Acceleration 0-62mph	8.5 (8.7)
FUEL CONSUMPTION [†]	
UX Front-Wheel Drive mpg (l/100km)	50.4 (5.6) - 53.2 (5.3)
UX E-FOUR mpg (l/100km)	47.0 (6.0) - 47.0 (6.0)
CO ₂ EMISSIONS [†]	
Combined FWD (g/km)	128 - 120
Combined E-FOUR (g/km)	137 - 135
WEIGHTS (kg)	
Gross vehicle	2110
Kerb (min. - max.)	1540 - 1620 (1600 - 1680 E-FOUR)
CAPACITIES ¹	
Luggage volume - rear seats upright, loaded to luggage cover (l)	320 (283 E-FOUR)
Luggage volume - rear seats upright, loaded to the roof (l)	438 (401 E-FOUR)
Luggage volume - rear seats folded, loaded to the roof (l)	1231 (1194 E-FOUR)
Fuel tank capacity (l)	43
Towing capacity max. unbraked (kg)	750
Towing capacity max. braked (kg)	750
Drawbar capacity (kg)	75

[†]Figures are provided for comparability purposes; only compare fuel consumption and CO₂ figures with other cars tested to the same technical procedures. These figures may not reflect real life driving results. All vehicles are certified according to the World Harmonised Light Vehicle Test Procedure (WLTP). CO₂ figures (and hence car tax and recommended 'on the road' prices) may differ from information printed before 1 April 2020, due to a change in the official method of calculation. This date may change, please visit www.vehicle-certification-agency.gov.uk/lcb/wltp.asp for the latest information. For details of your preferred model and grade derivative, please contact your local Lexus Centre. Choice of options and accessories fitted (pre-registration) may affect the official CO₂ figures, car tax and 'on the road' price.

¹Luggage volumes shown are in-house measured values. All figures quoted include the maximum under floor storage area in the luggage compartment.

Please note: further Technical Data, including any updates, can be found at www.lexus.co.uk

TECHNICAL DATA

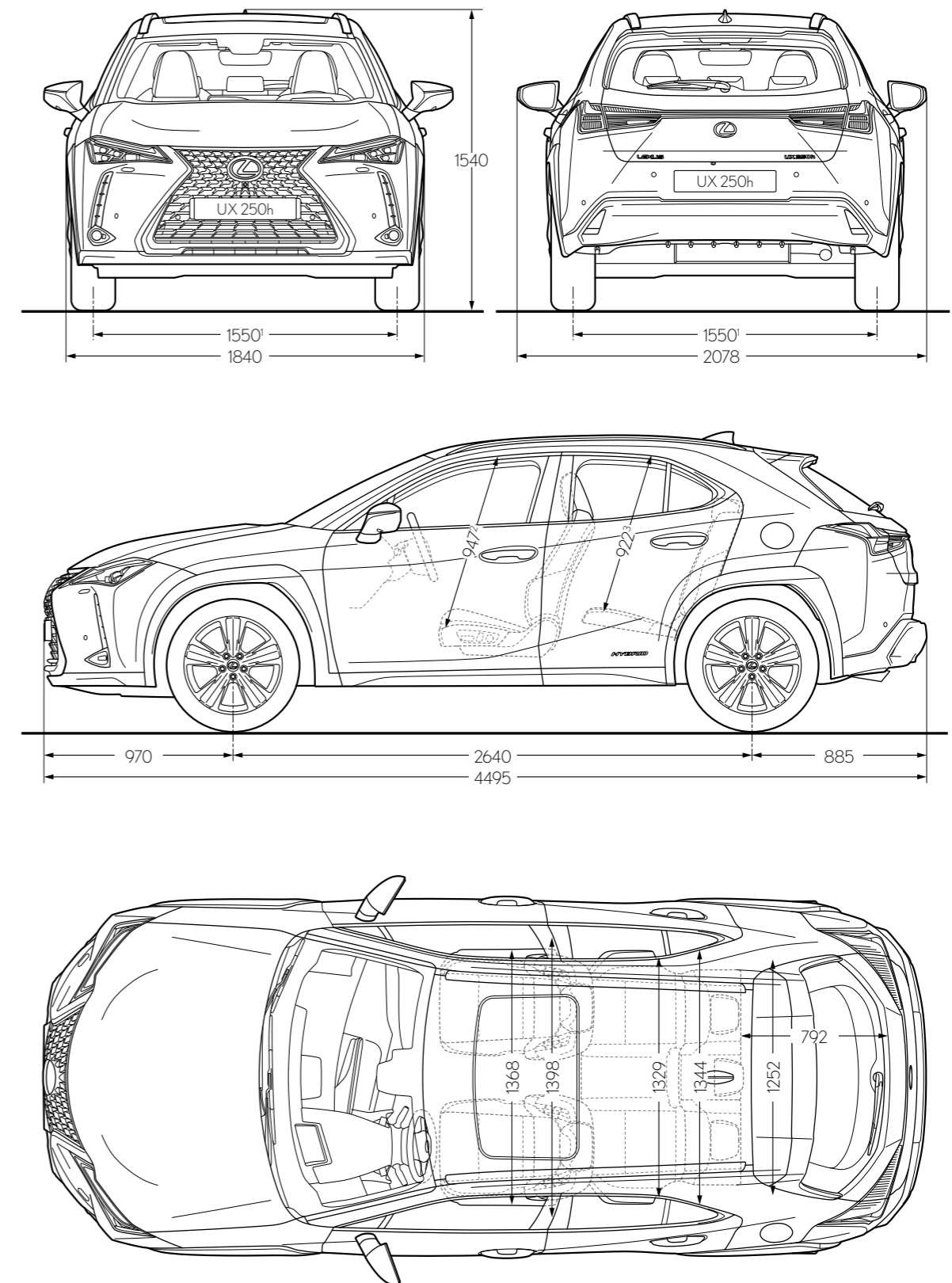

¹When specified with 215/60 R17 tyres, both the front and rear track figures are 1560.

²Figure quoted is for models specified with the standard roof. Equivalent figure for F SPORT models is 929. For models specified with the optional glass sunroof, the figure is 908 or 889 for F SPORT models.

³Figure quoted is for models specified with the standard roof. Equivalent figure with the optional glass sunroof specified is 924.

Please note: the dimensions illustrated / noted are measured in millimetres.



UX 250h



Throughout your vehicle's life, we'll endeavour to ensure an amazing ownership experience, offering unequalled service and seamless maintenance work, all orchestrated to provide complete satisfaction and total peace of mind. When you visit our showrooms, we strive to anticipate your every need and make available the finest facilities for you to enjoy in a warm and relaxed atmosphere. In the modern Lexus lounge, you can catch up on news, browse the Internet or enjoy refreshments. While you relax, Lexus technicians will work with precision and efficiency to get you back on the road with minimum interruption to your day.



WE AIM TO TREAT EVERY CUSTOMER AS IF THEY WERE A GUEST IN OUR OWN HOME

Ever since we launched the first Lexus, we have always gone 'the extra mile' for our customers. Evidenced by countless awards over the last 25 years, we aim to treat every customer as if they were a guest in our home. But which other factors contribute to our peerless level of customer service? The answer lies in our Japanese heritage and one word: 'Omotenashi'.

Omotenashi translates from the Japanese as 'hospitality and polite service'. However, Omotenashi is much more than excellence of service; it is an ancient Japanese concept that describes one's ability to anticipate the needs of another, even before they arise.

Omotenashi is a way of life and thinking for every single Lexus employee. Importantly, it also influences how we design and engineer cars like the new UX. This is Omotenashi in physical form.



More about the new UX:

lexus.co.uk/UX

GBNGL-UX420-VB

April 2020

Lexus created vehicles born from imaginative design, pioneering technology and craftsmanship. Only behind the wheel of one of our models can you truly experience amazing. Simply consult your local Lexus Centre to arrange a test drive at your convenience. To find out more about Lexus vehicles or to locate your local Lexus Centre, please visit our website www.lexus.co.uk or call 0845 278 8888 (calls cost 2p per minute plus your phone company's access charge.)

Accuracy and specification

All information contained in this brochure was correct at the time of going to print. Please note that while every effort is made to reproduce accurate information, we reserve the right to change specification, equipment and availability without prior notice. Images shown in this brochure may not be of UK models (for example, they may show left-hand drive vehicles) and may illustrate equipment that is only available on selected grades. Therefore, this brochure cannot be regarded as infallible and, as such, does not constitute an offer for sale of any particular vehicle shown.

Fuel consumption and emissions data

[†]Figures are provided for comparability purposes; only compare fuel consumption and CO₂ figures with other cars tested to the same technical procedures. These figures may not reflect real life driving results. Fuel consumption and CO₂ produced varies significantly depending on a number of factors, including the accessories fitted (post-registration), driving style, conditions, speed and vehicle load.

All models and grades are certified according to the World Harmonised Light Vehicle Test Procedure (WLTP). All mpg and CO₂ figures quoted are full WLTP figures.

The official CO₂ figures for vehicles have changed, due to a change in the official method of calculation. CO₂ figures are used in the calculation of Vehicle Excise Duty (car tax) for new cars during their first year of registration. As a result, all CO₂ figures, car tax and 'on the road' prices for new vehicles, which were provided or displayed prior to 1 April 2020, may now have changed for vehicles which were not registered before that date. These dates may change, please visit www.vehicle-certification-agency.gov.uk/fcb/wltp.asp for the latest information.

Choice of options and accessories fitted (pre-registration) may affect the official CO₂ figures, car tax and 'on the road' price.

For details of your preferred model and grade derivative, please contact your local Lexus Centre.

Safe driving

Lexus is committed to promoting safe and responsible driving at all times. None of the images contained in this brochure should be taken to promote any unsafe driving practice. All sound, entertainment and navigation accessories that may be included in our vehicles should always be used alongside legal and attentive driving. Additionally, any driver assistance and other safety features included in our vehicles are not designed to substitute safe and careful driving.

End-of-life vehicles

Taking care of the environment is a priority for Lexus. We strive to minimise the environmental impact of our vehicles throughout their life cycle - from design, production, distribution, sales and service to end-of-life. For more detailed information on environmental performance, please visit www.lexus.co.uk/environment

About Lexus

Lexus is a division of Toyota (GB) PLC registered in England & Wales with company number 0916634 with its registered office at Great Burgh, Burgh Heath, Epsom, Surrey KT18 5UX. Toyota (GB) PLC is an appointed representative of Toyota Insurance Management Limited and Toyota Financial Services (UK) PLC, both of which are authorised and regulated by the Financial Conduct Authority.

Printed Brochures

Lexus brochures are produced by printers that hold the environmental accreditation 'ISO 14001', and use paper that is FSC (Forest Stewardship Council) certified, which is sourced from sustainably managed forests. The inks used are vegetable oil based and the coatings are aqueous based. Once you have finished with this brochure, please pass it onto someone else to enjoy. If disposing of this brochure, please place it in a recycling bin.