



THE

SALOON & TOURING



Best viewed in landscape mode



THE BMW 3 SERIES SALOON & TOURING.

RETURN BY CLICKING [🏠](#)
SELECT A TOPIC BELOW TO EXPLORE:



FEATURED MODELS.

BMW 330i M SPORT SALOON WITH M SPORT PRO PACKAGE:

BMW TwinPower Turbo four-cylinder petrol engine, 258hp (190kW), 19" M light alloy Double-spoke style 791 M wheels in Bicolour Jet Black, exterior paint in Portimao Blue metallic, BMW Laserlights, Sun protection glass, Adaptive M Suspension, M rear spoiler, BMW Individual High-gloss Shadowline exterior trim, BMW Individual lights Shadowline, Instrument panel in Sensatec, Sport seats in Vernasca Black leather with Blue contrast stitching, M seat belts, interior trim in Aluminium Tetragon.

BMW 330i M SPORT PRO EDITION TOURING:

BMW TwinPower Turbo four-cylinder petrol engine, 258hp (190kW), 19" M light alloy Double-spoke style 791 M wheels in Jet Black with mixed tyres, exterior paint in Dravitz Grey metallic, BMW Laserlights, Sport seats in Oyster Vernasca leather with Grey contrast stitching.

Content correct at time of publishing (as of March 2021). Prices and technical data subject to change. The models shown on these pages may feature optional equipment. Standard equipment may also vary depending on engine variant. For further details, please contact your local BMW Centre.



3 SERIES TOURING.



"BOOT SPACE IS UP THERE WITH THE BEST IN CLASS AND ACCESSIBILITY IS EXCELLENT THANKS TO THE ABSENCE OF ANY NOTABLE SILL. ALL MODELS GET AN AUTOMATIC TAILGATE AS STANDARD."

Autocar

[Read the full review](#)

3 SERIES SALOON.



"THE LATEST 3 SERIES GOES STRAIGHT TO THE TOP OF THE COMPACT EXECUTIVE CLASS."

Auto Express

[Read the full review](#)



3 SERIES SALOON.

"THE 3 SERIES IS ONE OF THE SAFEST CARS YOU AND YOUR FAMILY COULD BE IN."

What Car?

[Read the full review](#)



3 SERIES SALOON.



"IT'S THE BEST 3 SERIES I'VE DRIVEN IN YEARS, AS WELL AS THE MOST ROUNDED."

CAR magazine

[Read the full review](#)





3 SERIES SALOON.



"OUTSTANDING DRIVER APPEAL."

Autocar

[Read the full review](#)

3 SERIES TOURING.



"FANTASTIC TO DRIVE, SMART INSIDE AND HAS ONE OF THE BEST INFOTAINMENT SYSTEMS ON THE MARKET."

What Car?

[Read the full review](#)

M340i/d xDRIVE.



The BMW 3 Series M340i xDrive Saloon model is shown above in Black Sapphire metallic paint.

■ Standard equipment □ Optional equipment

M340i/d xDRIVE.



In addition / replacement to M Sport models

EXTERIOR

- Cerium Grey finish, comprises:
 - Air inlets
 - Kidney grilles
 - Mirror caps
 - Model designation
- M Sport braking system, High-gloss Red calipers
- M rear spoiler (Saloon only)
- 19" M light alloy Double-spoke style 792 M wheels, Bicolour Cerium Grey with mixed and run-flat tyres
- Metallic paintwork
- Exhaust tailpipes – square, dual

INTERIOR

- M seat belts
- Instrument panel in Sensatec
- Sport seats, front
- Sun protection glass
- M Leather steering wheel
- Headlining, Anthracite

SAFETY & TECHNOLOGY

- M Sport braking system
- M Sport differential
- Adaptive M suspension
- Sport automatic transmission
- 48V Mild Hybrid Technology
- BMW TwinPower Turbo six-cylinder in-line petrol engine (M340i xDrive only)
- BMW TwinPower Turbo six-cylinder in-line diesel engine (M340d xDrive only)

AUDIO & COMMUNICATION

- Loudspeaker system – BMW Advanced



The BMW 3 Series M340i xDrive Saloon model is shown above in Black Sapphire metallic paint.

■ Standard equipment □ Optional equipment

M SPORT & M SPORT PRO EDITION.



The BMW 3 Series M Sport Pro Edition Touring model is shown above in Dravit Grey metallic paint.

■ Standard equipment □ Optional equipment

M SPORT & M SPORT PRO EDITION.

M SPORT.

In addition / replacement to SE Pro models

EXTERIOR

- M aerodynamics bodystyling
- Exterior trim, High-gloss Shadowline
- Roof rails, BMW Individual High-gloss Shadowline (Touring only)
- 18" M light alloy Double-spoke style 790 M wheels, Bicolour Orbit Grey
- M designation on front side panels, left and right

INTERIOR

- Sport seats, front
- Vernasca leather upholstery
- Seat heating, front
- Headlining, Anthracite
- Interior trim, Aluminium Tetragon
- M Leather steering wheel
- Gear selection lever with M-specific designation (manual transmission only)

SAFETY & TECHNOLOGY

- M Sport braking system (exclusively for 330i / 330d / 330d xDrive)
- M Sport suspension
- Variable Sport Steering
- Automatic transmission (318i and 318d Touring only)
- Sport automatic transmission (excludes 318i and 318d)
- Manual transmission (318d Saloon only)
- Larger fuel tank, total of 59 litres
- Vehicle key with M-specific designation

AUDIO & COMMUNICATION

- Loudspeaker system – BMW Advanced (330i only)

M SPORT PRO EDITION.

In addition / replacement to M Sport models

EXTERIOR

- BMW Individual High-gloss Shadowline exterior trim with extended contents
- Mirror caps, Black
- BMW M Sport Plus Edition unique paintwork
- BMW Individual lights Shadowline
- 19" M light alloy Double-spoke style 791 M wheels, Jet Black with mixed and run-flat tyres

INTERIOR

- Sport seats, front
- M seat belts
- Sun protection glass
- BMW Individual interior trim, Aluminium Fabric, High-gloss
- Headlining, Anthracite
- M Leather steering wheel

SAFETY & TECHNOLOGY

- M Sport braking system
- Adaptive M suspension
- M Sport differential (330i Touring / 330d / 330d xDrive only)
- Variable Sport Steering

SPORT PRO.



The BMW 3 Series Sport Pro Touring model is featured above in Mineral White metallic paint.

■ Standard equipment □ Optional equipment

SPORT PRO.

In addition / replacement to SE Pro models

EXTERIOR

- Exterior trim, High-gloss Shadowline
- Roof rails, High-gloss Shadowline (Touring only)
- 18" light alloy V-spoke style 780 wheels, Bicolour Orbit Grey with run-flat tyres
- T-shaped design element right and left in Black, High-gloss
- Front and rear bumper with specific design elements in High-gloss, Black
- Roof mouldings in body colour

INTERIOR

- Sport seats, front
- Vernasca leather upholstery
- Seat heating, front
- Aluminium door sill finishers in the front with BMW designation
- Sport multi-function steering wheel, three-spoke

SAFETY & TECHNOLOGY

- Sport automatic transmission
- Larger fuel tank, total of 59 litres



The BMW 3 Series Sport Pro Touring model is featured above in Mineral White metallic paint.

■ Standard equipment □ Optional equipment

SE PRO.



The BMW 3 Series SE Pro Saloon model is shown above in Melbourne Red metallic paint.

■ Standard equipment □ Optional equipment

SE PRO.

EXTERIOR

- Adaptive LED headlights
- Exterior mirrors – electrically folding with anti-dazzle
- Active Air Stream Kidney grille, Chrome frame with eight Black, High-gloss vertical slats
- Split-folding rear seats
- Exterior trim, Matt Black
- 17" light alloy V-spoke style 778 wheels
- Brake lights with LED technology, Dynamic
- Exhaust tailpipes – split, left and right

INTERIOR

- Ambient lighting
- Acoustic glazing
- Air conditioning, automatic with three-zone control
- Interior mirror with automatic anti-dazzle function
- Interior trim, High-gloss Black
- Anthracite cloth upholstery
- Floor mats, velour
- Sport multi-function steering wheel, three-spoke

SAFETY & TECHNOLOGY

- Parking Assistant with Reversing Camera
- Active Guard Plus
- Park Distance Control (PDC), front and rear
- 48V Mild Hybrid Technology (318d automatic transmission [Saloon] / 318d [Touring] / 320d / 320d xDrive only)
- Preparation for High-beam Assistant
- Cruise control with braking function
- xDrive (320i xDrive Saloon / 330e xDrive / 320d xDrive only)
- Automatic transmission (318i only)
- Eight-speed sport automatic transmission with gearshift paddles (excludes 318i / 318d)
- Manual transmission (318d Saloon only)
- BMW Mobility kit
- Rain sensor with automatic headlight activation and windscreen wiper control
- Tyre pressure monitoring

AUDIO & COMMUNICATION

- BMW Live Cockpit Professional, comprising:
 - 10.25" Control Display with Touch Function
 - 12.3" Digital Instrument Display
 - BMW Intelligent Personal Assistant
 - Intelligent Functionalities
 - BMW Navigation system
 - Digital Driver Cockpit
 - Remote Software Upgrade
 - BMW Operating System 7.0
- Connected Package Professional
- Bluetooth hands-free facility with USB audio interface
- BMW Emergency Call
- BMW Online Services
- DAB tuner



THE BMW 330e & 330e xDRIVE.

Featuring innovative BMW eDrive and EfficientDynamics technologies, the BMW 330e and 330e xDrive provides impressive levels of performance and efficiency. Offering the best of both worlds, this Plug-in Hybrid Electric Vehicle (PHEV) combines a powerful petrol engine with an electric motor that is powered by a lithium-ion battery, overall providing an exceptionally pure electric driving range with the flexibility of a combustion engine. The BMW 330e and 330e xDrive is everything you would expect from a BMW and more, with electrifying driving pleasure, this represents the future of the Ultimate Driving Machine.

The BMW 330e and 330e xDrive – plug into the future today.



Pure electric range for Saloon:
34.2-37.3 miles (55.0-60.0km)*
Pure electric range for Touring:
32.3-37.3 miles (52.0-60.0km)*

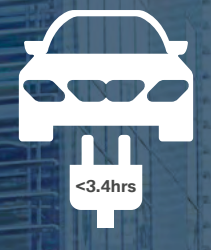

Charging time 0-80% in <3.4 hours (based on a current of 16A)^



Low CO₂ emissions for Saloon:
38-30g/km*
Low CO₂ emissions for Touring:
42-32g/km*



SALOON.

DRIVING ELECTRIC AWARDS 2019

Winner
Best Medium Plug-in Hybrid

[Read the full review](#)



The BMW 330e Sport Pro Saloon model is shown above in Mineral White metallic paint. ^ = Dependent on the local electricity infrastructure. Charging time corresponds to a charge of 80% of maximum capacity and based on a single-phase supply current of max 32A. * = For Plug-in Hybrid Electric Vehicles these figures were obtained using a combination of battery power and fuel. Plug-in Hybrid Electric Vehicles require mains electricity for charging. Figures shown are for comparability purposes. Only compare fuel consumption, CO₂ and electric range figures with other cars tested to the same technical procedures. These figures may not reflect real life driving results, which will depend upon a number of factors including the starting charge of the battery, accessories fitted (post-registration), variations in weather, driving styles and vehicle load.



[Click here](#) to discover the key benefits of the BMW PHEV range.

EXTERIOR COLOURS.

EXCLUSIVELY FOR SE PRO & SPORT PRO MODELS.

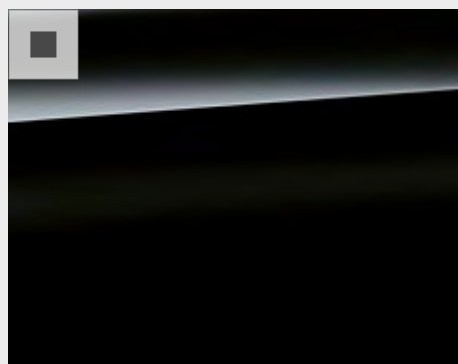

Non-metallic Jet Black

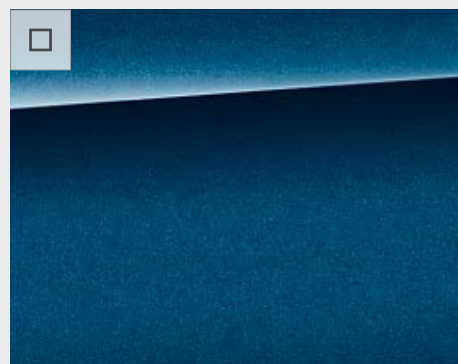

Metallic Phytonic Blue

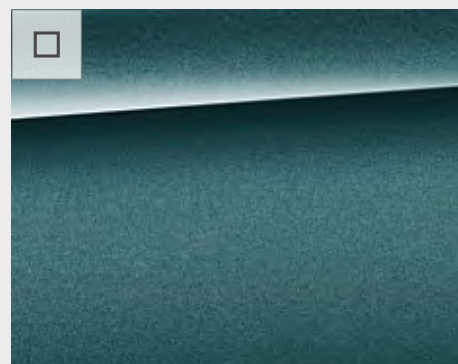

Metallic Blue Ridge Mountain



Metallic Glacier Silver¹

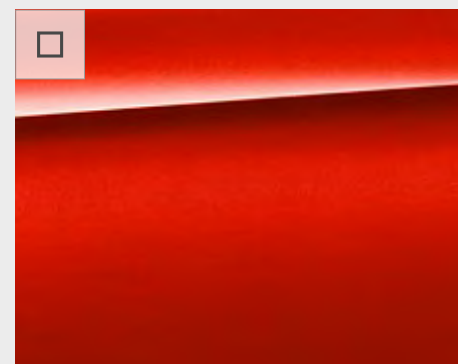

Metallic Melbourne Red

¹ = Not available on 320i and 320i xDrive SE Pro models.

EXCLUSIVELY FOR SE PRO, SPORT PRO, M SPORT & M340i/d xDRIVE MODELS.

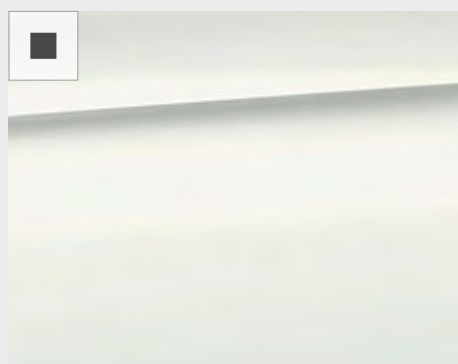

Non-metallic Alpine White

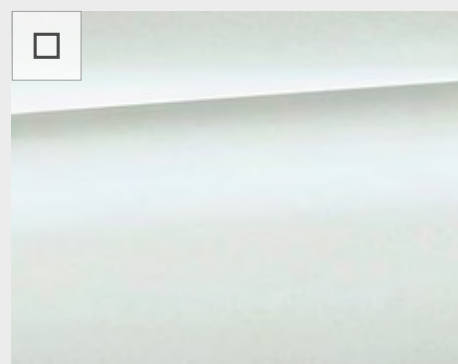

Metallic Mineral White

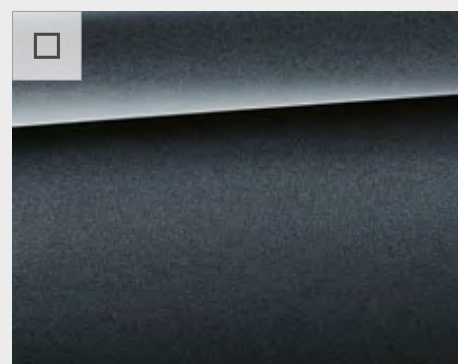

Metallic Mineral Grey

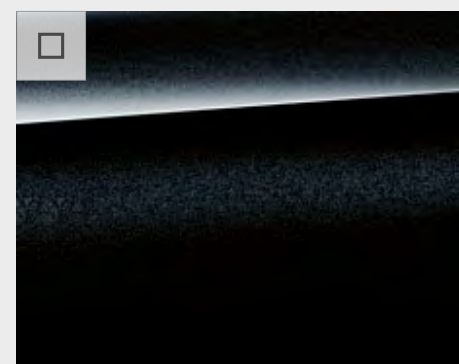

Metallic Black Sapphire

EXCLUSIVELY FOR SE PRO, SPORT PRO, M SPORT & M340i/d xDRIVE SALOON MODELS.

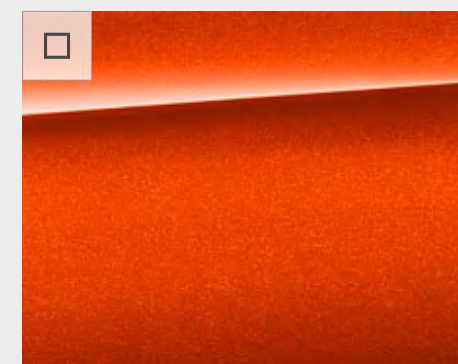

Metallic Sunset Orange

EXCLUSIVELY FOR M SPORT & M340i/d xDRIVE MODELS.



Metallic Portimao Blue

EXCLUSIVELY FOR M SPORT PRO EDITION & M340i/d xDRIVE MODELS.



BMW Individual Tanzanite Blue metallic

Standard for M Sport Pro Edition models.

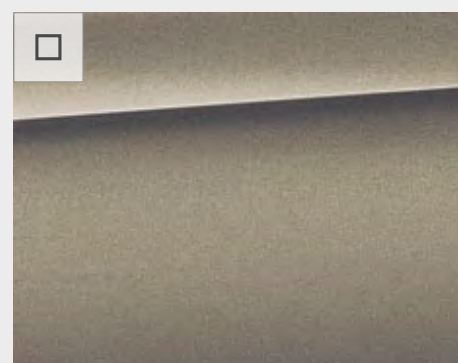

BMW Individual Oxide Grey metallic

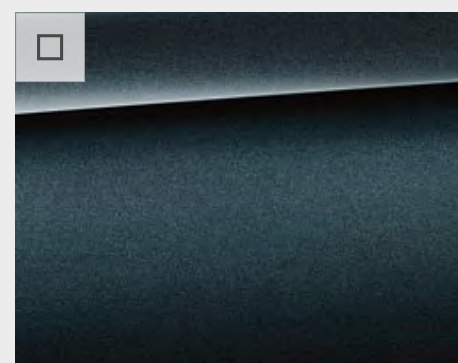

BMW Individual Dravit Grey metallic

Colour samples These colour samples are intended as an initial guide to the colours and materials available for your BMW. Please discuss your preferred colour choices with your BMW Centre. There you can also see original samples and be assisted with any requests.

■ Standard equipment □ Optional equipment

UPHOLSTERY.

CLOTH.



Cloth in Anthracite
Available with
■ SE Pro

SENSATEC.



Sensatec leather in Black
Available with
□ SE Pro

Exclusively available with SE Plus Package.

BMW INDIVIDUAL LEATHER.



BMW Individual Extended Merino leather in Ivory White
Available with
□ M Sport Pro Edition
□ M340i xDrive
□ M340d xDrive

BMW INDIVIDUAL LEATHER.



BMW Individual Full Merino leather in Ivory White
Available with
□ M340i xDrive
□ M340d xDrive

LEATHER.

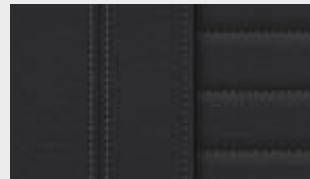

Vernasca leather in Black with Grey stitching
Available with
■ Sport Pro
■ M Sport
■ M Sport Pro Edition
■ M340i xDrive
■ M340d xDrive

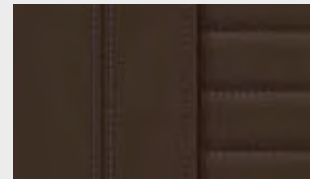

Vernasca leather in Mocha with Night Blue stitching
Available with
■ Sport Pro
■ M Sport
■ M Sport Pro Edition
■ M340i xDrive
■ M340d xDrive



BMW Individual Extended Merino leather in Fiona Red and Black
Available with
□ M Sport Pro Edition
□ M340i xDrive
□ M340d xDrive



BMW Individual Full Merino leather in Fiona Red and Black
Available with
□ M340i xDrive
□ M340d xDrive

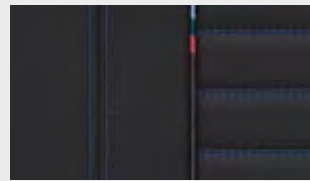

Vernasca leather in Black with Blue stitching
Available with
□ M Sport
□ M Sport Pro Edition
■ M340i xDrive
■ M340d xDrive

Exclusively available with Instrument panel in Sensatec.

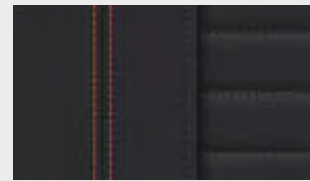

Vernasca leather in Black with Orange stitching
Available with
■ Sport Pro

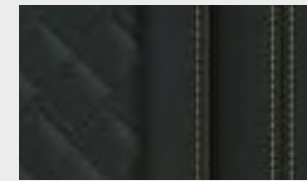

BMW Individual Extended Merino leather in Black
Available with
□ M Sport Pro Edition
□ M340i xDrive
□ M340d xDrive

BMW Individual Extended Merino leather only available with loudspeaker system – harman/kardon.

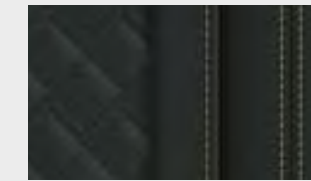

BMW Individual Full Merino leather in Black
Available with
□ M340i xDrive
□ M340d xDrive

BMW Individual Full Merino leather only with Extended storage and Instrument panel in leather.

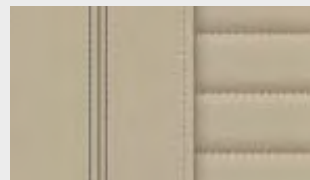

Vernasca leather in Oyster with Grey stitching
Available with
■ Sport Pro
■ M Sport
■ M Sport Pro Edition
■ M340i xDrive
■ M340d xDrive



Vernasca leather in Cognac with Mocha stitching
Available with
■ Sport Pro
■ M Sport
■ M Sport Pro Edition
■ M340i xDrive
■ M340d xDrive

INTERIOR TRIMS.

INTERIOR TRIMS.



High-gloss Black

Available with
 SE Pro
 Sport Pro



Aluminium Tetrakon

Available with
 M Sport
 M340i xDrive
 M340d xDrive

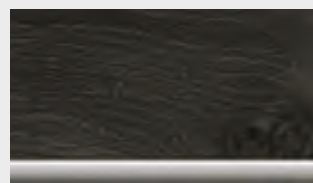

Finewood Oak grain, open-pored

Available with
 SE Pro
 Sport Pro
 M Sport
 M340i xDrive
 M340d xDrive

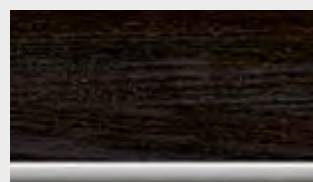

Finewood Ash Grey-Brown High-gloss

Available with
 SE Pro
 Sport Pro
 M Sport
 M340i xDrive
 M340d xDrive



Aluminium Mesh effect

Available with
 M Sport
 M340i xDrive
 M340d xDrive

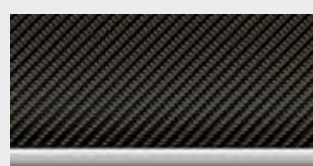

Carbon Fibre

Available with
 M340i xDrive
 M340d xDrive

BMW INDIVIDUAL.



Piano Black¹

Available with
 M Sport
 M Sport Pro Edition
 M340i xDrive
 M340d xDrive

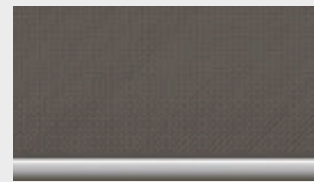

Aluminium Fabric High-gloss

Available with
 M Sport Pro Edition
 M340i xDrive
 M340d xDrive

HEADLINING.

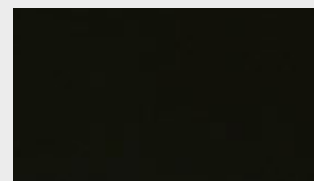

Anthracite

Available with
 M Sport
 M Sport Pro Edition
 M340i xDrive
 M340d xDrive

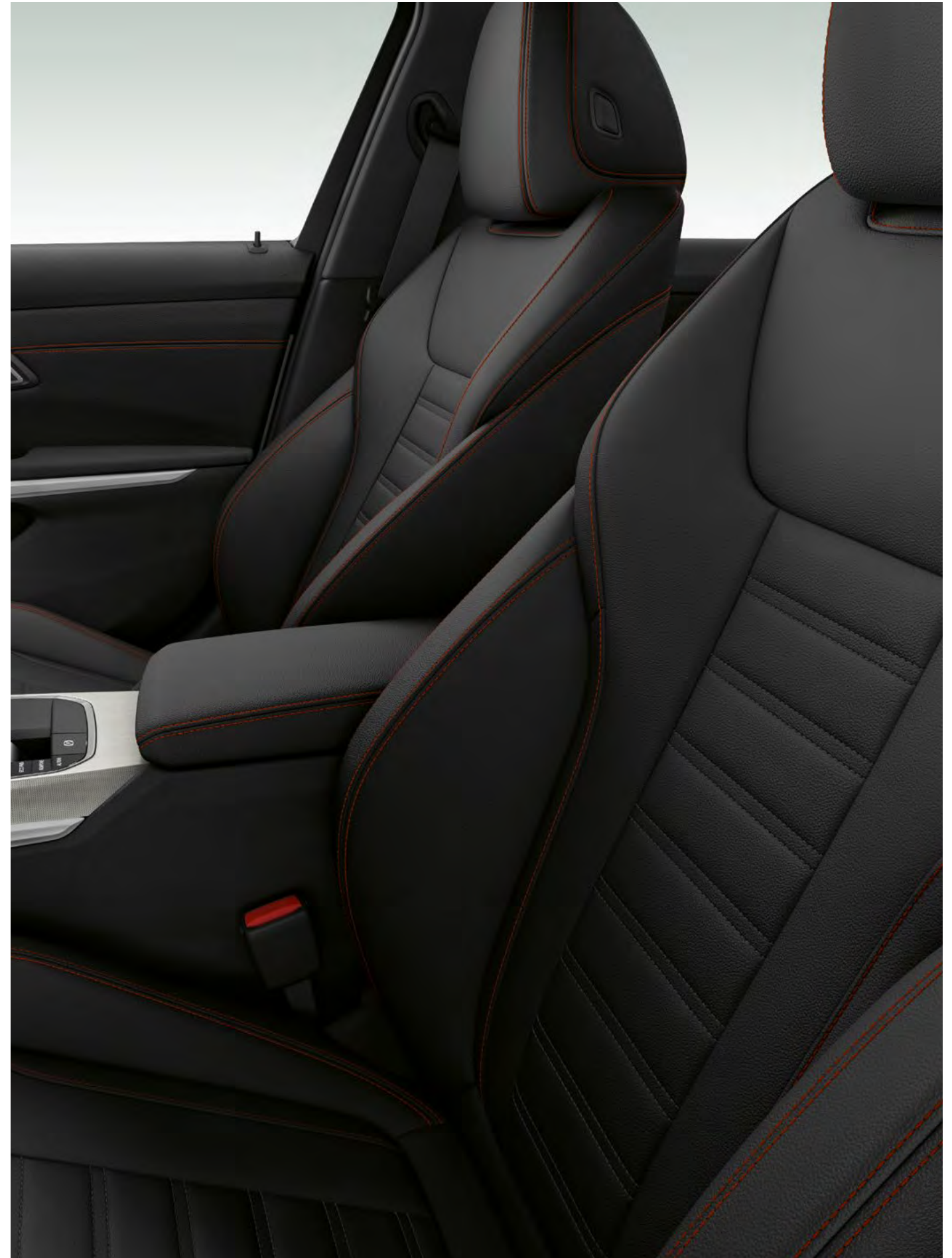

Please note that the interior colour depends on the selected upholstery colour. Please note that even normal long or short-term use can lead to permanent upholstery damage.
¹ = Not available on 320i and 320i xDrive models.

PACKAGES.

Optional packages offer an attractive combination of the most popular options at a reduced (combined) cost and will enhance any journey in the BMW 3 Series Saloon and Touring.

TECHNOLOGY PACKAGE.

- Head-up Display
- Enhanced Bluetooth with wireless charging
- WiFi hotspot preparation
- Loudspeaker system – harman/kardon
- BMW Gesture Control



TECHNOLOGY PLUS PACKAGE.

- Technology Package
- Parking Assistant Plus
- Drive Recorder
- Driving Assistant Professional



M CARBON PACKAGE.

- M Carbon Roof
- Interior trim, Carbon Fibre



Exclusively for M340i and M340d xDrive Saloon models.

SHADOWLINE PLUS.

- 19" M light alloy Double-spoke style 791 M wheels, Jet Black with mixed tyres
- Mirror caps, Black
- BMW Individual lights Shadowline
- Extended High-gloss Shadowline exterior trim



Exclusively available for M340i and M340d xDrive models.

SE PLUS PACKAGE.

- Black Sensatec leather upholstery
- Heated seats, front
- Larger fuel tank (increased to 59 litres) (excludes 330e / 330e xDrive)



Exclusively available for SE Pro models.

M SPORT PRO PACKAGE.

- 19" M light alloy Double-spoke style 791 M wheels, Bicolour Jet Black with run-flat tyres
- Adaptive M Suspension
- BMW Individual lights Shadowline
- Sun protection glass
- M seat belts
- Extended High-gloss Shadowline exterior trim

Differing content:

- M Sport braking system
- M Sport differential
- M rear spoiler
- Variable Sport Steering

Exclusively available for M Sport models.



COMFORT PACKAGE.

- Steering wheel heating
- Automatic tailgate operation (Saloon only)
- Luggage compartment package (Touring only)
- Comfort Access
- Extended storage



COMFORT PLUS PACKAGE.

- Comfort Package
- Seat adjustment – front, electric with driver memory
- Lumbar support, front



Not available on SE Pro models.

VISIBILITY PACKAGE.

- BMW Laserlights
- High-beam Assistant



OPTIONAL EQUIPMENT HIGHLIGHTS.

BMW LASERLIGHTS.

BMW Laserlights offer better visibility in the dark which significantly increases safety. They illuminate a range of up to 500m. BMW Laserlights includes:

- Low-beam headlights
- High-beam headlights
- Daytime driving lights
- Side turn indicators
- Adaptive headlights
- Cornering lights
- BMW selective beam

Exclusively available as part of Visibility Package.



DRIVING ASSISTANT PROFESSIONAL.

Driving Assistant Professional offers maximum comfort and safety during complex or monotonous driving situations. This feature includes:

- Active Cruise Control with approach control
- Active Lane guidance
- Automatic Speed Limit Assist
- Crossing traffic warning, front
- Crossroads warning and city braking function
- Evasion aid
- Lane Keeping Assistant with Active side collision protection
- Steering and Lane Control Assistant
- Wrong-way warning

Available as part of Technology Plus Package. Only available on vehicles with automatic transmission. Function may be limited in darkness, fog or bright glare.



COMFORT ACCESS WITH SMART OPENER.

Comfort Access allows access to the vehicle without removing the key from a pocket or bag. Sensors detect the proximity of the key to the vehicle and allow the doors to be unlocked by holding the door handle closest to the key. A Smart Opener allows a sweeping movement of the foot under the bumper for automatic opening and closing of the tailgate.

Exclusively available as part of Comfort Package and Comfort Plus Package. The Digital Key is available and active without runtime limitations. Usage cannot be guaranteed permanently due to potential future technical developments (of the Service availability and/or Smartphone compatibility/operating systems). Only available with a compatible iPhone®. Detailed information on the Digital key can be found in the ConnectedDrive Store.

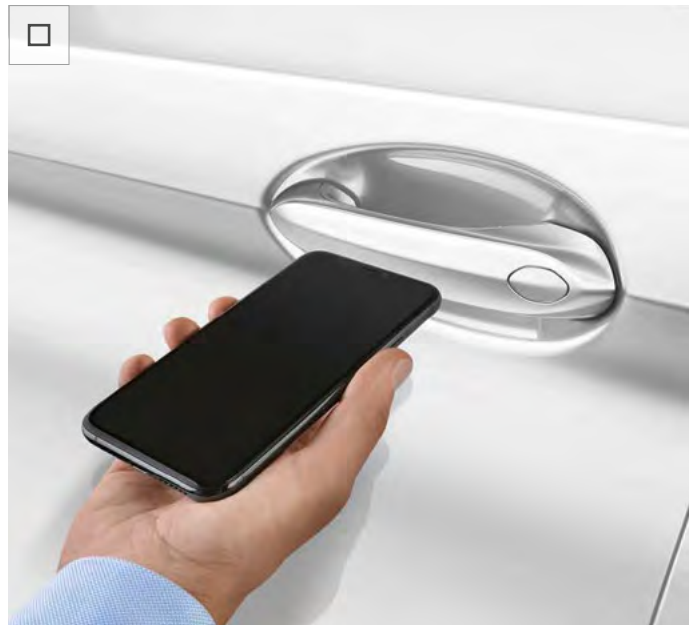

PARKING ASSISTANT PLUS.

Parking Assistant Plus makes parking and manoeuvring the vehicle easier. It includes the Surround View system and Remote 3D View as well as the functions of Parking Assistant and Park Distance Control.

Available as part of Technology Plus Package. Only with Drive Recorder.

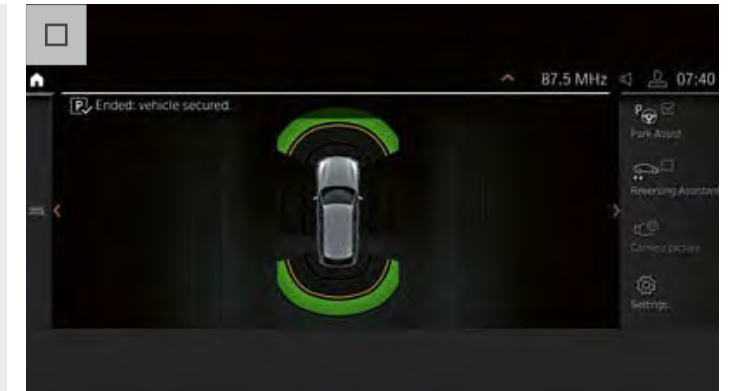

INSTRUMENT PANEL, SENSATEC.

The upper part of the instrument panel in Black Sensatec has a Blue seam and adds to the overall sporty aesthetic of the car.

Optionally available for M Sport and M Sport Pro Edition models. Standard for M340i xDrive and M340d xDrive. Only available with Black Vernasca leather upholstery with Blue contrast stitching.



LUGGAGE COMPARTMENT PACKAGE.

The Luggage Compartment Package has an automated sliding function for easier loading while stationary and an anti-slip rail function for when driving and parking on inclines.

Exclusively available as part of Comfort Package and Comfort Plus Package for Touring models. Automated sliding and anti-slip rail function not available for 330e / 330e xDrive models.



TOWBAR, FULLY ELECTRIC.

The towbar is concealed and permanently installed behind the bumper and is released and retracted electrically by means of a button in the luggage compartment. Trailer Stability Control is included when this option is specified.



BMW CONNECTED DRIVE.

BMW ConnectedDrive enables you to remain connected to the outside world from the comfort of your BMW.



- **BMW LIVE COCKPIT PROFESSIONAL.**
- **BMW Apps** makes it possible to operate apps such as BMW Connected.
- **BMW Emergency Call** automatically creates a direct link to the local emergency services.
- **BMW Intelligent Personal Assistant** understands natural speech. It interacts with your BMW and has the ability to learn driver preferences.
- **BMW Online Services** provides a seamless integration of personalised BMW Connected mobility-related services.
- **BMW Teleservices** supports the processing of servicing appointments and sends vehicle-specific service data to BMW.
- **Intelligent Functionalities** creates customised rules and learns the driver's habits to enable greater comfort on every journey.
- **Last State Call** transfers vehicle-based data to the BMW Connected App, allowing you to view current mileage, fuel status and other features from your phone.
- **Map updates** automatically updates the maps in your BMW by downloading them over the air.



- **CONNECTED PACKAGE PROFESSIONAL.**
- **BMW Maps** makes route planning easier, anticipates road conditions and provides an estimated time of arrival.
- **Concierge Services** connects the driver to a BMW Call Centre agent around-the-clock.
- **Connected Charging** enables the search and display of charging points, as well as the display of range and charging features for 330e and 330e xDrive models.
- The integrated **eDrive Zones**, for certain cities (London and Birmingham), ensures automatic switch to electric driving within set zones for Plug-in Hybrid Electric vehicles.
- **Connected Music** offers unlimited streaming of millions of songs in the vehicle from Spotify.
- **Connected Parking** offers multi-story and on-street parking information in selected cities in the UK and Europe.
- **In-Car Experiences** takes care of you and adapts the interior ambience to suit your mood.
- **Real Time Traffic Information** supplies details about the location and duration of traffic delays.
- **Remote Services** allows you to remain connected to your vehicle from your phone.
- With **Smartphone Integration**, your vehicle supports Apple CarPlay® and Android Auto®. This way you can access your usual apps in the vehicle.

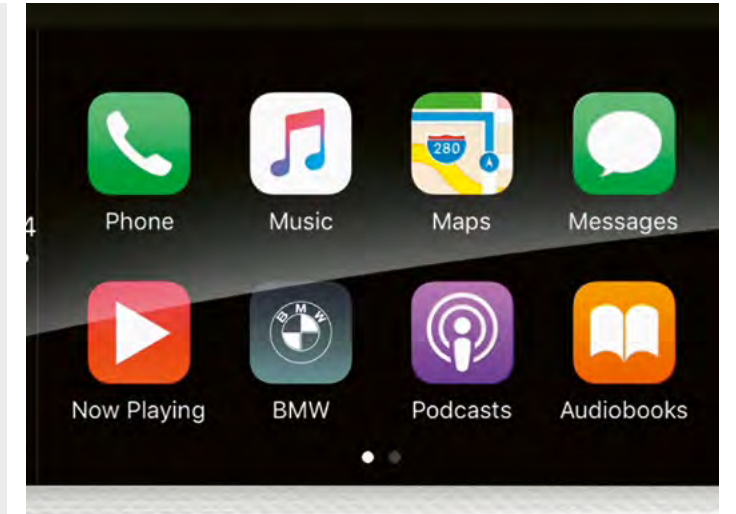

CONNECTED TEASER.

Three month trial of the following service:

- **BMW Music** brings your favourite soundtracks to your BMW.

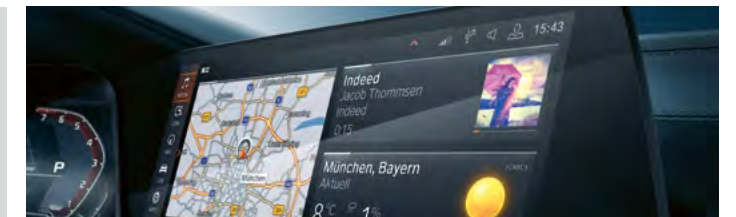

MY BMW APP.

The My BMW App is the direct connection inside and outside your BMW. Plan your next trip, check the status of your vehicle or use one of the remote service functions – all conveniently from your smartphone.

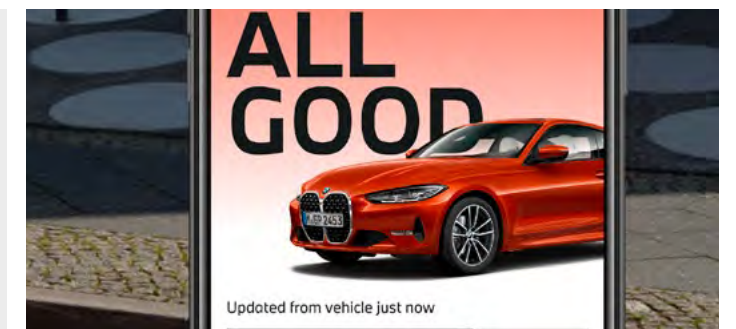

The information above is subject to change. Actual Control Display and content on the BMW 3 Series Saloon and Touring may vary from the images shown. For further details on these services, see [BMW ConnectedDrive Services](#).

■ Standard equipment □ Optional equipment

WHEELS & TYRES.

19" M LIGHT ALLOY DOUBLE-SPOKE STYLE 791 M WHEELS, BICOLOUR JET BLACK.

19" M light alloy Double-spoke style 791 M wheels, Bicolour Jet Black, front 8 J x 19 with 225/40 R19, rear 8.5 J x 19 255/35 R19 run-flat tyres.

Optional for M Sport and M Sport Pro Edition models. Only in combination with the M Sport Pro Package.



18" M LIGHT ALLOY DOUBLE-SPOKE STYLE 790 M WHEELS, BICOLOUR ORBIT GREY.

18" M light alloy Double-spoke style 790 M wheels, Bicolour Orbit Grey, front 7.5 J x 18 with 225/45 R18, rear 8.5 J x 18 with 255/40 tyres.

Available as an optional downgrade on the M340i xDrive.



19" BMW INDIVIDUAL LIGHT ALLOY DOUBLE-SPOKE STYLE 793 WHEELS, BICOLOUR ORBIT GREY.

19" BMW Individual light alloy Double-spoke style 793 wheels, Bicolour Orbit Grey, front 8 J x 19 with 225/40 R19 run-flat tyres, rear 8.5 J x 19 with 255/35 R19 run-flat tyres.

Optional for Sport Pro and M Sport models. Not available with the M Sport Pro Package.



18" LIGHT ALLOY DOUBLE-SPOKE STYLE 782 WHEELS, BICOLOUR ORBIT GREY.

18" light alloy Double-spoke style 782 wheels, Bicolour Orbit Grey, 7.5 J x 18 with 225/45 R18 tyres.

Optional on SE Pro models, excludes 330e and 330e xDrive models.



19" M LIGHT ALLOY DOUBLE-SPOKE STYLE 791 M WHEELS, JET BLACK.

19" M light alloy Double-spoke style 791 M wheels, Jet Black, front 8 J x 19 with 225/40 R19 run-flat tyres, rear 8.5 J x 19 with 255/35 R19 run-flat tyres.

Standard on M Sport Pro Edition and optional for M340i/d xDrive models.



18" LIGHT ALLOY V-SPOKE 780 WHEELS, BICOLOUR ORBIT GREY.

18" light alloy V-spoke style 780 wheels, Bicolour Orbit Grey, 7.5 J x 18 with 225/45 R18 tyres.

Exclusively for 330e and 330e xDrive Sport Pro Touring models, 18" light alloy V-spoke style 780 wheels, Bicolour Orbit Grey, front 7.5 J x 18 with 225/45 R18 tyres, rear 8.5 J x 18 with 255/40 R18 tyres.

Standard on Sport Pro models, including 330e and 330e xDrive Sport Pro Saloon.



19" M LIGHT ALLOY DOUBLE-SPOKE STYLE 792 M WHEELS, BICOLOUR CERIUM GREY.

19" M light alloy Double-spoke style 792 M wheels, Bicolour Cerium Grey, front 8 J x 19 with 225/40 R19 run-flat tyres, rear 8.5 J x 19 with 255/35 R19 run-flat tyres.

Standard for M340i xDrive and M340d xDrive models.



17" LIGHT ALLOY V-SPOKE STYLE 778 WHEELS.

17" light alloy V-spoke style 778 wheels, 7.5 J x 17 with 225/50 R17 non run-flat tyres.

Standard on SE Pro models.



GENUINE BMW ACCESSORIES.

BMW M PERFORMANCE ACCESSORIES.

There are a range of eye-catching BMW M Performance products available for the BMW 3 Series. These include Front Splitter (Matt Black) and Front Splitter Pro (Carbon), Rear Diffuser (available in Carbon or Matt Black) and Rear Spoiler (available in Carbon or Matt Black).



18" M PERFORMANCE LIGHT ALLOY DOUBLE-SPOKE STYLE 796 M WHEELS, JET BLACK.

High-quality 18" M Performance light alloy Double-spoke style 796 M wheels in Jet Black matt. TPMS winter complete wheel with run-flat tyres.



ROOF BOX, BLACK.

The modern BMW roof box in Black with Titanium Silver side panels has a storage capacity of 420 litres and is compatible with all BMW roof rack systems. Due to the fact that it can be opened from both sides and has triple central locking on each side it is convenient to load and lock for theft protection. BMW roof boxes in other sizes are also available.



BMW ROOF BARS.

BMW Roof Bars allow you to carry a number of items on the roof of your car, including roof boxes and bike carriers.

BMW ADVANCED CAR EYE.

BMW Advanced Car Eye 2.0 is a highly sensitive full HD camera, which automatically records what is going on around the vehicle during disturbances and driving situations.



BMW REAR BIKE CARRIER.

The BMW Rear Bike Carrier is lightweight yet sturdy and can carry up to 60kg. Exceptionally easy to use, it carries two bicycles or e-bikes. Its tilt function also allows easy access to the luggage compartment at all times.



LUGGAGE COMPARTMENT MAT.

Anti-slip, water-resistant mat for protecting the luggage compartment from dirt and moisture. In Black with stainless steel inlay matching the interior.



Discover the all-round innovative solutions on offer in many categories: exterior, interior, communication & information and transport & luggage compartment. Your BMW Centre will be happy to advise you and provide information about the entire range of Genuine BMW Accessories. For further information, please visit www.bmw.co.uk/accessories

PRICING INFORMATION.

THE BMW 3 SERIES SALOON.
PETROL.



318i SE Pro	318i M Sport	320i SE Pro	320i M Sport	320i xDrive SE Pro	320i xDrive M Sport	330i Sport Pro	330i M Sport	M340i xDrive
-------------	--------------	-------------	--------------	--------------------	---------------------	----------------	--------------	--------------

Basic price (excluding VAT)	£26,225.00	£27,683.33	£28,179.17	£29,720.83	£29,512.50	£30,970.83	£32,641.67	£32,933.33	£40,925.00
VAT 20%	£5,245.00	£5,536.67	£5,635.83	£5,944.17	£5,902.50	£6,194.17	£6,528.33	£6,586.67	£8,185.00
RRP (including VAT)	£31,470	£33,220	£33,815	£35,665	£35,415	£37,165	£39,170	£39,520	£49,110
On the road price from	£32,590	£34,340	£34,935	£36,785	£36,860	£38,610	£40,290	£40,640	£50,875
P11d value – Automatic	£32,320	£34,070	£34,665	£36,515	£36,265	£38,015	£40,020	£40,370	£49,960
BIK tax rate (2020 / 2021)	(32%-31%)	(33%-32%)	(32%)	(34%-32%)	(34%-33%)	(35%-33%)	(34%-32%)	(34%-32%)	(37%)
Insurance group	24	25	29	30	28	28	32	32	39
RDE2 Compliant (Y / N)	Y	Y	Y	Y	Y	Y	Y	Y	Y

PRICES AND SPECIFICATIONS

BMW (UK) Limited reserves the right to alter prices and specifications without notice. BMW (UK) Limited has made every effort to ensure the accuracy of information but does not accept liability for any errors or omissions.

VED RATES

Annual VED (second year onwards), for cars costing over £40,000, is payable for five years. VED rates for brand new cars are determined by their CO₂ emissions figure. First year VED applies to the first year of ownership. Annual VED rates apply thereafter. The BMW 3 Series Saloon models fall into one of the categories listed below:

CO ₂ emissions (g/km)	01-50	51-75	76-90	91-100	101-110	111-130	131-150	151-170	171-190	191-225	226-255	Over 255
First year VED (petrol and RDE2 diesel)	£10	£25	£110	£135	£155	£175	£215	£540	£870	£1,305	£1,850	£2,175
Annual VED – second year onwards (standard rate for petrol and diesel)	£150	£150	£150	£150	£150	£150	£150	£150	£150	£150	£150	£150
Annual VED – second year onwards (petrol and diesel cars over £40,000)	£475	£475	£475	£475	£475	£475	£475	£475	£475	£475	£475	£475

ON THE ROAD PRICE

The recommended on the road price includes:

Delivery and BMW Emergency Service	£825
Number plates	£25
Vehicle first registration fee	£55
First year Vehicle Excise Duty	See left

Figures shown are for comparability purposes. Only compare fuel consumption, CO₂ and electric range figures with other cars tested to the same technical procedures. These figures may not reflect real life driving results, which will depend upon a number of factors including the starting charge of the battery, accessories fitted (post-registration), variations in weather, driving styles and vehicle load. The CO₂ figures have been determined according to the WLTP test. WLTP has been used as the applicable CO₂ figure from 1 April 2020 for first year vehicle tax (VED) and from 6 April 2020 for company car tax (BIK). The CO₂ figures were previously based on the NEDC equivalent. Figures in () apply to cars with automatic transmission. Insurance group figures refer to 50 Group Rating System.

PRICING INFORMATION.

THE BMW 3 SERIES SALOON.
PLUG-IN HYBRID ELECTRIC VEHICLES.



	330e SE Pro	330e Sport Pro	330e M Sport	330e M Sport Pro Edition	330e xDrive SE Pro	330e xDrive Sport Pro	330e xDrive M Sport	330e xDrive M Sport Pro Edition
Basic price (excluding VAT)	£32,604.17	£33,770.83	£34,358.33	£38,108.33	£33,895.83	£35,062.50	£35,650.00	£39,400.00
VAT 20%	£6,520.83	£6,754.17	£6,871.67	£7,621.67	£6,779.17	£7,012.50	£7,130.00	£7,880.00
RRP (including VAT)	£39,125	£40,525	£41,230	£45,730	£40,675	£42,075	£42,780	£47,280
On the road price from	£40,030	£41,430	£42,135	£46,635	£41,580	£42,980	£43,685	£48,185
P11d value – Automatic	£39,975	£41,375	£42,080	£46,580	£41,525	£42,925	£43,630	£48,130
BIK tax rate (2020 / 2021)	(10%)	(10%)	(10%)	(10%)	(10%)	(10%)	(10%)	(10%)
Insurance group	33	33	33	35	34	34	34	35
RDE2 Compliant (Y / N)	Y	Y	Y	Y	Y	Y	Y	Y

PRICES AND SPECIFICATIONS

BMW (UK) Limited reserves the right to alter prices and specifications without notice. BMW (UK) Limited has made every effort to ensure the accuracy of information but does not accept liability for any errors or omissions.

VED RATES

Annual VED (second year onwards), for cars costing over £40,000, is payable for five years. VED rates for brand new cars are determined by their CO₂ emissions figure. First year VED applies to the first year of ownership. Annual VED rates apply thereafter. The BMW 3 Series Saloon models fall into one of the categories listed below:

CO ₂ emissions (g/km)	01-50	51-75	76-90	91-100	101-110	111-130	131-150	151-170	171-190	191-225	226-255	Over 255
First year VED (alternative fuel vehicles)	£0	£15	£100	£125	£145	£165	£205	£530	£860	£1,295	£1,840	£2,165
Annual VED – second year onwards (alternative fuel vehicles over £40,000)	£465	£465	£465	£465	£465	£465	£465	£465	£465	£465	£465	£465

ON THE ROAD PRICE

The recommended on the road price includes:

Delivery and BMW Emergency Service	£825
Number plates	£25
Vehicle first registration fee	£55
First year Vehicle Excise Duty	See left

Figures shown are for comparability purposes. Only compare fuel consumption, CO₂ and electric range figures with other cars tested to the same technical procedures. These figures may not reflect real life driving results, which will depend upon a number of factors including the starting charge of the battery, accessories fitted (post-registration), variations in weather, driving styles and vehicle load. The CO₂ figures have been determined according to the WLTP test. WLTP has been used as the applicable CO₂ figure from 1 April 2020 for first year vehicle tax (VED) and from 6 April 2020 for company car tax (BIK). The CO₂ figures were previously based on the NEDC equivalent. Figures in () apply to cars with automatic transmission. Insurance group figures refer to 50 Group Rating System.

PRICING INFORMATION.

THE BMW 3 SERIES SALOON.
DIESEL.



318d SE Pro	318d M Sport	320d SE Pro	320d M Sport	320d M Sport Pro Edition	320d xDrive SE Pro	320d xDrive M Sport	320d xDrive M Sport Pro Edition	330d Sport Pro	330d M Sport	330d M Sport Pro Edition	330d xDrive Sport Pro	330d xDrive M Sport	330d xDrive M Sport Pro Edition	M340d xDrive
-------------	--------------	-------------	--------------	--------------------------	--------------------	---------------------	---------------------------------	----------------	--------------	--------------------------	-----------------------	---------------------	---------------------------------	--------------

Basic price (excluding VAT)	£28,179.17	£29,637.50	£30,658.33	£32,158.33	£36,158.33	£31,950.00	£33,450.00	£37,450.00	£34,408.33	£34,700.00	£38,450.00	£35,700.00	£35,991.67	£39,741.67	£40,925.00
VAT 20%	£5,635.83	£5,927.50	£6,131.67	£6,431.67	£7,231.67	£6,390.00	£6,690.00	£7,490.00	£6,881.67	£6,940.00	£7,690.00	£7,140.00	£7,198.33	£7,948.33	£8,185.00
RRP (including VAT)	£33,815	£35,565	£36,790	£38,590	£43,390	£38,340	£40,140	£44,940	£41,290	£41,640	£46,140	£42,840	£43,190	£47,690	£49,110
On the road price from	£34,895	£36,645	£37,860	£39,660	£44,460	£39,410	£41,250	£46,050	£42,400	£42,750	£47,250	£43,950	£44,300	£48,800	£50,545
P11d value – Manual	£34,665	£36,415	-	-	-	-	-	-	-	-	-	-	-	-	-
P11d value – Automatic	£36,215	£37,965	£37,640	£39,440	£44,240	£39,190	£40,990	£45,790	£42,140	£42,490	£46,990	£43,690	£44,040	£48,540	£49,960
BIK tax rate (2020 / 2021)	29%-28% (27%-26%)	30%-28% (29%-27%)	(28%-27%)	(29%-27%)	(29%-28%)	(29%-28%)	(31%-29%)	(31%-30%)	(30%-29%)	(30%-29%)	(30%)	(32%-31%)	(32%-31%)	(32%)	(35%-34%)
Insurance group	26	27	30	31	32	30	31	32	40	40	41	40	40	41	42
RDE2 Compliant (Y / N)	Y	Y	Y	Y	Y	Y	Y	Y	Y	Y	Y	Y	Y	Y	Y

PRICES AND SPECIFICATIONS

BMW (UK) Limited reserves the right to alter prices and specifications without notice. BMW (UK) Limited has made every effort to ensure the accuracy of information but does not accept liability for any errors or omissions.

VED RATES

Annual VED (second year onwards), for cars costing over £40,000, is payable for five years. VED rates for brand new cars are determined by their CO₂ emissions figure. First year VED applies to the first year of ownership. Annual VED rates apply thereafter. The BMW 3 Series Saloon models fall into one of the categories listed below:

CO ₂ emissions (g/km)	01-50	51-75	76-90	91-100	101-110	111-130	131-150	151-170	171-190	191-225	226-255	Over 255
First year VED (petrol and RDE2 diesel)	£10	£25	£110	£135	£155	£175	£215	£540	£870	£1,305	£1,850	£2,175
First year VED (diesel)	£25	£110	£135	£155	£175	£215	£540	£870	£1,305	£1,850	£2,175	£2,175
Annual VED – second year onwards (standard rate for petrol and diesel)	£150	£150	£150	£150	£150	£150	£150	£150	£150	£150	£150	£150
Annual VED – second year onwards (petrol and diesel cars over £40,000)	£475	£475	£475	£475	£475	£475	£475	£475	£475	£475	£475	£475

ON THE ROAD PRICE

The recommended on the road price includes:

Delivery and BMW Emergency Service	£825
Number plates	£25
Vehicle first registration fee	£55
First year Vehicle Excise Duty	See left

Figures shown are for comparability purposes. Only compare fuel consumption, CO₂ and electric range figures with other cars tested to the same technical procedures. These figures may not reflect real life driving results, which will depend upon a number of factors including the starting charge of the battery, accessories fitted (post-registration), variations in weather, driving styles and vehicle load. The CO₂ figures have been determined according to the WLTP test. WLTP has been used as the applicable CO₂ figure from 1 April 2020 for first year vehicle tax (VED) and from 6 April 2020 for company car tax (BIK). The CO₂ figures were previously based on the NEDC equivalent. Figures in () apply to cars with automatic transmission. Insurance group figures refer to 50 Group Rating System.

PRICING INFORMATION.

THE BMW 3 SERIES TOURING.
PETROL.



	318i SE Pro	318i M Sport	320i SE Pro	320i M Sport	320i M Sport Pro Edition	330i Sport Pro	330i M Sport	330i M Sport Pro Edition	M340i xDrive
--	-------------	--------------	-------------	--------------	--------------------------	----------------	--------------	--------------------------	--------------

Basic price (excluding VAT)	£27,475.00	£28,933.33	£29,429.17	£30,970.83	£34,970.83	£33,891.67	£34,183.33	£37,933.33	£42,175.00
VAT 20%	£5,495.00	£5,786.67	£5,885.83	£6,194.17	£6,994.17	£6,778.33	£6,836.67	£7,586.67	£8,435.00
RRP (including VAT)	£32,970	£34,720	£35,315	£37,165	£41,965	£40,670	£41,020	£45,520	£50,610
On the road price from	£34,415	£36,165	£36,760	£38,610	£43,410	£42,115	£42,465	£46,965	£52,375
P11d value – Automatic	£33,820	£35,570	£36,165	£38,015	£42,815	£41,520	£41,870	£46,370	£51,460
BIK tax rate (2020 / 2021)	(34%-33%)	(35%-33%)	(34%-33%)	(35%-33%)	(35%-34%)	(35%-34%)	(36%-34%)	(36%-35%)	(37%)
Insurance group	24	25	29	30	30	32	32	34	40
RDE2 Compliant (Y / N)	(Y)	(Y)	(Y)	(Y)	(Y)	(Y)	(Y)	(Y)	(Y)

PRICES AND SPECIFICATIONS

BMW (UK) Limited reserves the right to alter prices and specifications without notice. BMW (UK) Limited has made every effort to ensure the accuracy of information but does not accept liability for any errors or omissions.

VED RATES

Annual VED (second year onwards), for cars costing over £40,000, is payable for five years. VED rates for brand new cars are determined by their CO₂ emissions figure. First year VED applies to the first year of ownership. Annual VED rates apply thereafter. The BMW 3 Series Touring models fall into one of the categories listed below:

CO ₂ emissions (g/km)	01-50	51-75	76-90	91-100	101-110	111-130	131-150	151-170	171-190	191-225	226-255	Over 255
First year VED (petrol and RDE2 diesel)	£10	£25	£110	£135	£155	£175	£215	£540	£870	£1,305	£1,850	£2,175
Annual VED – second year onwards (standard rate for petrol and diesel)	£150	£150	£150	£150	£150	£150	£150	£150	£150	£150	£150	£150
Annual VED – second year onwards (petrol and diesel cars over £40,000)	£475	£475	£475	£475	£475	£475	£475	£475	£475	£475	£475	£475

ON THE ROAD PRICE

The recommended on the road price includes:

Delivery and BMW Emergency Service	£825
Number plates	£25
Vehicle first registration fee	£55
First year Vehicle Excise Duty	See left

Figures shown are for comparability purposes. Only compare fuel consumption, CO₂ and electric range figures with other cars tested to the same technical procedures. These figures may not reflect real life driving results, which will depend upon a number of factors including the starting charge of the battery, accessories fitted (post-registration), variations in weather, driving styles and vehicle load. The CO₂ figures have been determined according to the WLTP test. WLTP has been used as the applicable CO₂ figure from 1 April 2020 for first year vehicle tax (VED) and from 6 April 2020 for company car tax (BIK). The CO₂ figures were previously based on the NEDC equivalent. Figures in () apply to cars with automatic transmission. Insurance group figures refer to 50 Group Rating System.

PRICING INFORMATION.

THE BMW 3 SERIES TOURING.
PLUG-IN HYBRID ELECTRIC VEHICLES.



	330e SE Pro	330e Sport Pro	330e M Sport	330e M Sport Pro Edition	330e xDrive SE Pro	330e xDrive Sport Pro	330e xDrive M Sport	330e xDrive M Sport Pro Edition
Basic price (excluding VAT)	£33,854.17	£35,020.83	£35,608.33	£39,358.33	£35,145.83	£36,312.50	£36,900.00	£40,650.00
VAT 20%	£6,770.83	£7,004.17	£7,121.67	£7,871.67	£7,029.17	£7,262.50	£7,380.00	£8,130.00
RRP (including VAT)	£40,625	£42,025	£42,730	£47,230	£42,175	£43,575	£44,280	£48,780
On the road price from	£41,530	£42,930	£43,635	£48,135	£43,080	£44,480	£45,185	£49,685
P11d value – Automatic	£41,475	£42,875	£43,580	£48,080	£43,025	£44,425	£45,130	£49,630
BIK tax rate (2020 / 2021)	(10%)	(10%)	(10%)	(10%)	(10%)	(10%)	(10%)	(10%)
Insurance group	34	34	35	36	34	35	35	36
RDE2 Compliant (Y / N)	(Y)	(Y)	(Y)	(Y)	(Y)	(Y)	(Y)	(Y)

PRICES AND SPECIFICATIONS

BMW (UK) Limited reserves the right to alter prices and specifications without notice. BMW (UK) Limited has made every effort to ensure the accuracy of information but does not accept liability for any errors or omissions.

VED RATES

Annual VED (second year onwards), for cars costing over £40,000, is payable for five years. VED rates for brand new cars are determined by their CO₂ emissions figure. First year VED applies to the first year of ownership. Annual VED rates apply thereafter. The BMW 3 Series Touring models fall into one of the categories listed below:

CO ₂ emissions (g/km)	01-50	51-75	76-90	91-100	101-110	111-130	131-150	151-170	171-190	191-225	226-255	Over 255
First year VED (alternative fuel vehicles)	£0	£15	£100	£125	£145	£165	£205	£530	£860	£1,295	£1,840	£2,165
Annual VED – second year onwards (alternative fuel vehicles over £40,000)	£465	£465	£465	£465	£465	£465	£465	£465	£465	£465	£465	£465

ON THE ROAD PRICE

The recommended on the road price includes:

Delivery and BMW Emergency Service	£825
Number plates	£25
Vehicle first registration fee	£55
First year Vehicle Excise Duty	See left

Figures shown are for comparability purposes. Only compare fuel consumption, CO₂ and electric range figures with other cars tested to the same technical procedures. These figures may not reflect real life driving results, which will depend upon a number of factors including the starting charge of the battery, accessories fitted (post-registration), variations in weather, driving styles and vehicle load. The CO₂ figures have been determined according to the WLTP test. WLTP has been used as the applicable CO₂ figure from 1 April 2020 for first year vehicle tax (VED) and from 6 April 2020 for company car tax (BIK). The CO₂ figures were previously based on the NEDC equivalent. Figures in () apply to cars with automatic transmission. Insurance group figures refer to 50 Group Rating System.

PRICING INFORMATION.

THE BMW 3 SERIES TOURING.
DIESEL.



318d SE Pro	318d M Sport	320d SE Pro	320d M Sport	320d M Sport Pro Edition	320d xDrive SE Pro	320d xDrive M Sport	320d xDrive M Sport Pro Edition	330d Sport Pro	330d M Sport	330d M Sport Pro Edition	330d xDrive Sport Pro	330d xDrive M Sport	330d xDrive M Sport Pro Edition	M340d xDrive
-------------	--------------	-------------	--------------	--------------------------	--------------------	---------------------	---------------------------------	----------------	--------------	--------------------------	-----------------------	---------------------	---------------------------------	--------------

Basic price (excluding VAT)	£30,720.83	£32,179.17	£31,908.33	£33,408.33	£37,408.33	£33,200.00	£34,700.00	£38,700.00	£35,658.33	£35,950.00	£39,700.00	£36,950.00	£37,241.67	£40,991.67	£42,175.00
VAT 20%	£6,144.17	£6,435.83	£6,381.67	£6,681.67	£7,481.67	£6,640.00	£6,940.00	£7,740.00	£7,131.67	£7,190.00	£7,940.00	£7,390.00	£7,448.33	£8,198.33	£8,435.00
RRP (including VAT)	£36,865	£38,615	£38,290	£40,090	£44,890	£39,840	£41,640	£46,440	£42,790	£43,140	£47,640	£44,340	£44,690	£49,190	£50,610
On the road price from	£37,935	£39,685	£39,360	£41,160	£46,000	£40,950	£42,750	£47,550	£43,900	£44,250	£48,750	£45,450	£45,800	£50,625	£52,045
P11d value – Automatic	£37,715	£39,465	£39,140	£40,940	£45,740	£40,690	£42,490	£47,290	£43,640	£43,990	£48,490	£45,190	£45,540	£50,040	£51,460
BIK tax rate (2020 / 2021)	(29%-28%)	(30%-28%)	(29%-28%)	(30%-29%)	(30%)	(30%)	(32%-30%)	(32%-31%)	(31%-30%)	(32%-30%)	(32%-31%)	(33%-32%)	(33%-32%)	(33%)	(36%)
Insurance group	25	26	30	31	32	30	30	31	40	40	41	40	40	41	42
RDE2 Compliant (Y / N)	(Y)	(Y)	(Y)	(Y)	(Y)	(Y)	(Y)	(Y)	(Y)	(Y)	(Y)	(Y)	(Y)	(Y)	(Y)

PRICES AND SPECIFICATIONS

BMW (UK) Limited reserves the right to alter prices and specifications without notice. BMW (UK) Limited has made every effort to ensure the accuracy of information but does not accept liability for any errors or omissions.

VED RATES

Annual VED (second year onwards), for cars costing over £40,000, is payable for five years. VED rates for brand new cars are determined by their CO₂ emissions figure. First year VED applies to the first year of ownership. Annual VED rates apply thereafter. The BMW 3 Series Touring models fall into one of the categories listed below:

CO ₂ emissions (g/km)	01-50	51-75	76-90	91-100	101-110	111-130	131-150	151-170	171-190	191-225	226-255	Over 255
First year VED (petrol and RDE2 diesel)	£10	£25	£110	£135	£155	£175	£215	£540	£870	£1,305	£1,850	£2,175
First year VED (diesel)	£25	£110	£135	£155	£175	£215	£540	£870	£1,305	£1,850	£2,175	£2,175
Annual VED – second year onwards (standard rate for petrol and diesel)	£150	£150	£150	£150	£150	£150	£150	£150	£150	£150	£150	£150
Annual VED – second year onwards (petrol and diesel cars over £40,000)	£475	£475	£475	£475	£475	£475	£475	£475	£475	£475	£475	£475

ON THE ROAD PRICE

The recommended on the road price includes:

Delivery and BMW Emergency Service	£825
Number plates	£25
Vehicle first registration fee	£55
First year Vehicle Excise Duty	See left

Figures shown are for comparability purposes. Only compare fuel consumption, CO₂ and electric range figures with other cars tested to the same technical procedures. These figures may not reflect real life driving results, which will depend upon a number of factors including the starting charge of the battery, accessories fitted (post-registration), variations in weather, driving styles and vehicle load. The CO₂ figures have been determined according to the WLTP test. WLTP has been used as the applicable CO₂ figure from 1 April 2020 for first year vehicle tax (VED) and from 6 April 2020 for company car tax (BIK). The CO₂ figures were previously based on the NEDC equivalent. Figures in () apply to cars with automatic transmission. Insurance group figures refer to 50 Group Rating System.

TECHNICAL INFORMATION.

THE BMW 3 SERIES SALOON.
PETROL.



318i SE Pro

318i M Sport

320i SE Pro

320i M Sport

320i xDrive SE Pro

320i xDrive M Sport

330i Sport Pro

330i M Sport

M340i xDrive

Power output (hp)	156	156	184	184	184	184	258	258	374
0-62mph / 0-100km/h (secs)	(8.4)	(8.4)	(7.1)	(7.1)	(7.6)	(7.6)	(5.8)	(5.8)	(4.4)
Fuel consumption – combined (mpg)*	(43.5-44.8)	(41.5-44.1)	(42.8-44.1)	(41.5-44.1)	(40.9-42.2)	(39.2-41.5)	TBC	TBC	(35.8-36.7)
Fuel consumption – combined (l/100km)*	(6.5-6.3)	(6.8-6.4)	(6.6-6.4)	(6.8-6.4)	(6.9-6.7)	(7.2-6.8)	(6.9-6.5)	(6.9-6.5)	(7.9-7.7)
CO ₂ emissions – combined (g/km)*	(149-144)	(154-146)	(149-145)	(155-146)	(157-153)	(164-154)	(156-148)	(157-148)	(180-176)
Mild Hybrid Technology [†] (Y / N)	(N)	(N)	(N)	(N)	(N)	(N)	(N)	(N)	(Y)

CO₂ value will vary dependent on vehicle specification. Build your BMW and view the CO₂ figure for your chosen model [here](#). * = Figures shown are for comparability purposes. Only compare fuel consumption, CO₂ and electric range figures with other cars tested to the same technical procedures. These figures may not reflect real life driving results, which will depend upon a number of factors including the starting charge of the battery, accessories fitted (post-registration), variations in weather, driving styles and vehicle load. The CO₂ figures have been determined according to the WLTP test. WLTP has been used as the applicable CO₂ figure from 1 April 2020 for first year vehicle tax (VED) and from 6 April 2020 for company car tax (BIK). The CO₂ figures were previously based on the NEDC equivalent. † = 48V Mild Hybrid Technology provides many benefits including improved recovery of kinetic energy during braking and support of the combustion engine when accelerating. This helps to reduce CO₂ emissions whilst improving fuel consumption and performance. Figures in () apply to cars with automatic transmission.

TECHNICAL INFORMATION.

THE BMW 3 SERIES SALOON.
PLUG-IN HYBRID ELECTRIC VEHICLES.



	330e SE Pro	330e Sport Pro	330e M Sport	330e M Sport Pro Edition	330e xDrive SE Pro	330e xDrive Sport Pro	330e xDrive M Sport	330e xDrive M Sport Pro Edition
Power output (hp)	292 [^]	292 [^]	292 [^]	292 [^]	292 [^]	292 [^]	292 [^]	292 [^]
0-62mph / 0-100km/h (secs)	(5.8)	(5.8)	(5.8)	(5.8)	(5.8)	(5.8)	(5.8)	(5.8)
Fuel consumption – weighted combined (mpg)*	(201.8-217.3)	(176.6-201.8)	(176.6-201.8)	(176.6-188.3)	(188.3-201.8)	(176.6-201.8)	(166.2-201.8)	(166.2-176.6)
Fuel consumption – weighted combined (l/100km)*	(1.4-1.3)	(1.6-1.4)	(1.6-1.4)	(1.6-1.5)	(1.5-1.4)	(1.6-1.4)	(1.7-1.4)	(1.7-1.6)
CO ₂ emissions – combined (g/km)*	(32-30)	(36-31)	(36-31)	(36-34)	(34-32)	(37-32)	(38-32)	(38-36)
Electric energy consumption – weighted combined (miles/kWh)*	(3.7-3.8)	(3.6-3.7)	(3.6-3.7)	(3.6)	(3.7)	(3.5-3.7)	(3.5-3.7)	(3.5-3.6)
Electric energy consumption – weighted combined (km/kWh)*	(16.9-16.5)	(17.5-16.7)	(17.5-16.7)	(17.5-17.3)	(16.9-16.6)	(17.6-16.7)	(17.6-16.7)	(17.6-17.3)
Equivalent all-electric range (miles)*	(36.0-37.3)	(34.8-36.7)	(34.8-36.7)	(34.8-35.4)	(36.0-37.3)	(34.2-36.7)	(34.2-36.7)	(34.2-34.8)
Equivalent all electric range (km)*	(58.0-60.0)	(56.0-59.0)	(56.0-59.0)	(56.0-57.0)	(58.0-60.0)	(55.0-59.0)	(55.0-59.0)	(55.0-56.0)
Mild Hybrid Technology [†] (Y / N)	(N)	(N)	(N)	(N)	(N)	(N)	(N)	(N)

CO₂ value will vary dependent on vehicle specification. Build your BMW and view the CO₂ figure for your chosen model [here](#). * = Figures shown are for comparability purposes. Only compare fuel consumption, CO₂ and electric range figures with other cars tested to the same technical procedures. These figures may not reflect real life driving results, which will depend upon a number of factors including the starting charge of the battery, accessories fitted (post-registration), variations in weather, driving styles and vehicle load. The CO₂ figures have been determined according to the WLTP test. WLTP has been used as the applicable CO₂ figure from 1 April 2020 for first year vehicle tax (VED) and from 6 April 2020 for company car tax (BIK). The CO₂ figures were previously based on the NEDC equivalent. † = 48V Mild Hybrid Technology provides many benefits including improved recovery of kinetic energy during braking and support of the combustion engine when accelerating. This helps to reduce CO₂ emissions whilst improving fuel consumption and performance. Figures in () apply to cars with automatic transmission. ^ = Combined power from Petrol and Electric engines.

TECHNICAL INFORMATION.

THE BMW 3 SERIES SALOON.
DIESEL.



318d SE Pro	318d M Sport	320d SE Pro	320d M Sport	320d M Sport Pro Edition	320d xDrive SE Pro	320d xDrive M Sport	320d xDrive M Sport Pro Edition	330d Sport Pro	330d M Sport	330d M Sport Pro Edition	330d xDrive Sport Pro	330d xDrive M Sport	330d xDrive M Sport Pro Edition	M340d xDrive
-------------	--------------	-------------	--------------	--------------------------	--------------------	---------------------	---------------------------------	----------------	--------------	--------------------------	-----------------------	---------------------	---------------------------------	--------------

Power output (hp)	150	150	190	190	190	190	190	190	286	286	286	286	286	286	340
0-62mph / 0-100km/h (secs)	8.4 (8.2)	8.4 (8.2)	(6.8)	(6.8)	(6.8)	(6.8)	(6.8)	(6.8)	(5.3)	(5.3)	(5.3)	(5.0)	(5.0)	(5.0)	(4.6)
Fuel consumption – combined (mpg)*	56.5-57.6 (60.1-62.8)	53.3-57.6 (57.6-61.4)	(58.9-60.1)	(56.5-60.1)	(56.5-57.6)	(55.4-57.6)	(53.3-56.5)	(53.3-54.3)	(53.3-56.5)	(53.3-56.5)	(53.3-54.3)	(50.4-53.3)	(50.4-53.3)	(50.4-51.4)	(45.6-46.3)
Fuel consumption – combined (l/100km)*	5.0-4.9 (4.7-4.5)	5.3-4.9 (4.9-4.6)	(4.8-4.7)	(5.0-4.7)	(5.0-4.9)	(5.1-4.9)	(5.3-5.0)	(5.3-5.2)	(5.3-5.0)	(5.3-5.0)	(5.3-5.2)	(5.6-5.3)	(5.6-5.3)	(5.6-5.5)	(6.2-6.1)
CO ₂ emissions – combined (g/km)*	132-127 (123-118)	138-129 (129-121)	(126-122)	(132-124)	(132-129)	(134-129)	(140-131)	(140-136)	(139-131)	(139-131)	(139-136)	(147-140)	(148-140)	(148-145)	(163-159)
Mild Hybrid Technology† (Y / N)	N (Y)	N (Y)	(Y)	(Y)	(Y)	(Y)	(Y)	(Y)	(Y)	(Y)	(Y)	(Y)	(Y)	(Y)	(Y)

CO₂ value will vary dependent on vehicle specification. Build your BMW and view the CO₂ figure for your chosen model [here](#). * = Figures shown are for comparability purposes. Only compare fuel consumption, CO₂ and electric range figures with other cars tested to the same technical procedures. These figures may not reflect real life driving results, which will depend upon a number of factors including the starting charge of the battery, accessories fitted (post-registration), variations in weather, driving styles and vehicle load. The CO₂ figures have been determined according to the WLTP test. WLTP has been used as the applicable CO₂ figure from 1 April 2020 for first year vehicle tax (VED) and from 6 April 2020 for company car tax (BIK). The CO₂ figures were previously based on the NEDC equivalent. † = 48V Mild Hybrid Technology provides many benefits including improved recovery of kinetic energy during braking and support of the combustion engine when accelerating. This helps to reduce CO₂ emissions whilst improving fuel consumption and performance. Figures in () apply to cars with automatic transmission.

TECHNICAL INFORMATION.

THE BMW 3 SERIES TOURING.
PETROL.



318i SE Pro

318i M Sport

320i SE Pro

320i M Sport

320i M Sport
Pro Edition

330i Sport Pro

330i M Sport

330i M Sport
Pro Edition

M340i xDrive

Power output (hp)	156	156	184	184	184	258	258	258	374
0-62mph / 0-100km/h (secs)	(8.7)	(8.7)	(7.5)	(7.5)	(7.5)	(6.0)	(6.0)	(6.0)	(4.6)
Fuel consumption – combined (mpg)*	(41.5-42.2)	(40.4-42.2)	(41.5-42.2)	(39.8-42.2)	(39.8-40.4)	(39.2-40.9)	(39.2-40.9)	(39.2-39.8)	(34.9-35.3)
Fuel consumption – combined (l/100km)*	(6.8-6.7)	(7.0-6.7)	(6.8-6.7)	(7.1-6.7)	(7.1-7.0)	(7.2-6.9)	(7.2-6.9)	(7.2-7.1)	(8.1-8.0)
CO ₂ emissions – combined (g/km)*	(155-152)	(160-153)	(155-152)	(161-153)	(161-158)	(164-156)	(165-157)	(165-163)	(184-182)
Mild Hybrid Technology† (Y / N)	(N)	(N)	(N)	(N)	(N)	(N)	(N)	(N)	(Y)

CO₂ value will vary dependent on vehicle specification. Build your BMW and view the CO₂ figure for your chosen model [here](#). * = Figures shown are for comparability purposes. Only compare fuel consumption, CO₂ and electric range figures with other cars tested to the same technical procedures. These figures may not reflect real life driving results, which will depend upon a number of factors including the starting charge of the battery, accessories fitted (post-registration), variations in weather, driving styles and vehicle load. The CO₂ figures have been determined according to the WLTP test. WLTP has been used as the applicable CO₂ figure from 1 April 2020 for first year vehicle tax (VED) and from 6 April 2020 for company car tax (BIK). The CO₂ figures were previously based on the NEDC equivalent. † = 48V Mild Hybrid Technology provides many benefits including improved recovery of kinetic energy during braking and support of the combustion engine when accelerating. This helps to reduce CO₂ emissions whilst improving fuel consumption and performance. Figures in () apply to cars with automatic transmission.

TECHNICAL INFORMATION.

THE BMW 3 SERIES TOURING.
PLUG-IN HYBRID ELECTRIC VEHICLES.



	330e SE Pro	330e Sport Pro	330e M Sport	330e M Sport Pro Edition	330e xDrive SE Pro	330e xDrive Sport Pro	330e xDrive M Sport	330e xDrive M Sport Pro Edition
Power output (hp)	292 [^]	292 [^]	292 [^]	292 [^]	292 [^]	292 [^]	292 [^]	292 [^]
0-62mph / 0-100km/h (secs)	(5.9)	(5.9)	(5.9)	(5.9)	(5.9)	(5.9)	(5.9)	(5.9)
Fuel consumption – combined (mpg)*	(188.3-201.8)	(176.6-201.8)	(176.6-201.8)	(176.6-188.3)	(166.2-176.6)	(156.9-176.6)	(156.9-176.6)	(156.9)
Fuel consumption – combined (l/100km)*	(1.5-1.4)	(1.6-1.4)	(1.6-1.4)	(1.6-1.5)	(1.7-1.6)	(1.8-1.6)	(1.8-1.6)	(1.8)
CO ₂ emissions – combined (g/km)*	(33-32)	(37-32)	(37-32)	(37-35)	(38-36)	(41-37)	(42-37)	(42-40)
Electric energy consumption – weighted combined (miles/kWh)*	(3.7-3.8)	(3.6-3.8)	(3.6-3.8)	(3.6-3.7)	(3.5-3.6)	(3.4-3.6)	(3.4-3.6)	(3.4-3.5)
Electric energy consumption – weighted combined (km/kWh)*	(16.7-16.4)	(17.3-16.5)	(17.3-16.5)	(17.3-17.0)	(17.7-17.4)	(18.2-17.5)	(18.3-17.5)	(18.3-18.0)
Equivalent all-electric range (miles)*	(36.7-37.3)	(34.8-37.3)	(34.8-37.3)	(34.8-36.0)	(34.2-34.8)	(32.3-34.2)	(32.3-34.2)	(32.3-32.9)
Equivalent all electric range (km)*	(59.0-60.0)	(56.0-60.0)	(56.0-60.0)	(56.0-58.0)	(55.0-56.0)	(52.0-55.0)	(52.0-55.0)	(52.0-53.0)
Mild Hybrid Technology [†] (Y / N)	(N)	(N)	(N)	(N)	(N)	(N)	(N)	(N)

CO₂ value will vary dependent on vehicle specification. Build your BMW and view the CO₂ figure for your chosen model [here](#). * = Figures shown are for comparability purposes. Only compare fuel consumption, CO₂ and electric range figures with other cars tested to the same technical procedures. These figures may not reflect real life driving results, which will depend upon a number of factors including the starting charge of the battery, accessories fitted (post-registration), variations in weather, driving styles and vehicle load. The CO₂ figures have been determined according to the WLTP test. WLTP has been used as the applicable CO₂ figure from 1 April 2020 for first year vehicle tax (VED) and from 6 April 2020 for company car tax (BIK). The CO₂ figures were previously based on the NEDC equivalent. † = 48V Mild Hybrid Technology provides many benefits including improved recovery of kinetic energy during braking and support of the combustion engine when accelerating. This helps to reduce CO₂ emissions whilst improving fuel consumption and performance. ^ = Combined power from Petrol and Electric engines. Figures in () apply to cars with automatic transmission.

TECHNICAL INFORMATION.

THE BMW 3 SERIES TOURING.
DIESEL.



318d SE Pro	318d M Sport	320d SE Pro	320d M Sport	320d M Sport Pro Edition	320d xDrive SE Pro	320d xDrive M Sport	320d xDrive M Sport Pro Edition	330d Sport Pro	330d M Sport	330d M Sport Pro Edition	330d xDrive Sport Pro	330d xDrive M Sport	330d xDrive M Sport Pro Edition	M340d xDrive
-------------	--------------	-------------	--------------	--------------------------	--------------------	---------------------	---------------------------------	----------------	--------------	--------------------------	-----------------------	---------------------	---------------------------------	--------------

Power output (hp)	150	150	190	190	190	190	190	286	286	286	286	286	286	340	
0-62mph / 0-100km/h (secs)	(8.7)	(8.7)	(7.1)	(7.1)	(7.1)	(7.4)	(7.4)	(5.5)	(5.5)	(5.5)	(5.2)	(5.2)	(5.2)	(4.8)	
Fuel consumption – combined (mpg)*	(57.6-58.9)	(54.3-57.6)	(56.5-57.6)	(53.3-56.5)	(53.3-54.3)	(53.3-54.3)	(50.4-54.3)	(50.4-51.4)	(51.4-54.3)	(51.4-54.3)	(51.4-52.3)	(48.7-51.4)	(47.9-50.4)	(47.9-48.7)	(44.1-44.8)
Fuel consumption – combined (l/100km)*	(4.9-4.8)	(5.2-4.9)	(5.0-4.9)	(5.3-5.0)	(5.3-5.2)	(5.3-5.2)	(5.6-5.2)	(5.6-5.5)	(5.5-5.2)	(5.5-5.2)	(5.5-5.4)	(5.8-5.5)	(5.9-5.6)	(5.9-5.8)	(6.4-6.3)
CO ₂ emissions – combined (g/km)*	(129-125)	(135-127)	(132-128)	(138-130)	(138-135)	(139-135)	(146-137)	(146-143)	(144-137)	(145-137)	(145-142)	(152-145)	(153-146)	(153-151)	(168-165)
Mild Hybrid Technology† (Y / N)	(Y)	(Y)	(Y)	(Y)	(Y)	(Y)	(Y)	(Y)	(Y)	(Y)	(Y)	(Y)	(Y)	(Y)	(Y)

CO₂ value will vary dependent on vehicle specification. Build your BMW and view the CO₂ figure for your chosen model [here](#). * = Figures shown are for comparability purposes. Only compare fuel consumption, CO₂ and electric range figures with other cars tested to the same technical procedures. These figures may not reflect real life driving results, which will depend upon a number of factors including the starting charge of the battery, accessories fitted (post-registration), variations in weather, driving styles and vehicle load. The CO₂ figures have been determined according to the WLTP test. WLTP has been used as the applicable CO₂ figure from 1 April 2020 for first year vehicle tax (VED) and from 6 April 2020 for company car tax (BIK). The CO₂ figures were previously based on the NEDC equivalent. † = 48V Mild Hybrid Technology provides many benefits including improved recovery of kinetic energy during braking and support of the combustion engine when accelerating. This helps to reduce CO₂ emissions whilst improving fuel consumption and performance. Figures in () apply to cars with automatic transmission.

OPTIONAL EQUIPMENT PRICING.

PETROL & PLUG-IN HYBRID ELECTRIC VEHICLES.



	318i SE Pro	318i M Sport	320i SE Pro	320i M Sport	320i M Sport Pro Edition	320i xDrive SE Pro*	320i xDrive M Sport*	330i Sport Pro	330i M Sport	330i M Sport Pro Edition [^]	330e SE Pro	330e Sport Pro	330e M Sport	330e M Sport Pro Edition	330e xDrive SE Pro	330e xDrive Sport Pro	330e xDrive M Sport	330e xDrive M Sport Pro Edition	M340i xDrive	Price
--	-------------	--------------	-------------	--------------	--------------------------	---------------------	----------------------	----------------	--------------	---------------------------------------	-------------	----------------	--------------	--------------------------	--------------------	-----------------------	---------------------	---------------------------------	--------------	-------

PAINTWORK

Non-metallic Available in Alpine White or Jet Black ¹	■	■	■	■	-	■	■	■	■	-	■	■	■	-	■	■	■	-	■	Std
Metallic Available in Black Sapphire, Blue Ridge Mountain ¹ , Glacier Silver ^{1,2} , Melbourne Red ¹ , Mineral Grey, Mineral White, Portimao Blue ³ or Phytonic Blue ¹	□	□	□	□	-	□	□	-	-	-	□	□	□	-	□	□	□	-	-	£670
	-	-	-	-	-	-	-	□	□	-	-	-	-	-	-	-	-	-	-	□
Available in Dravit Grey, Oxide Grey or Tanzanite Blue	-	-	-	-	■	-	-	-	-	■	-	-	-	■	-	-	-	■	□	£1,100

UPHOLSTERY

Cloth Available in Anthracite	■	-	■	-	-	■	-	-	-	-	■	-	-	-	■	-	-	-	-	Std
Sensatec leather Available in Black Only with SE Plus Package	□	-	□	-	-	□	-	-	-	-	□	-	-	-	□	-	-	-	-	n/a
Vernasca leather – Sport models Available in Black with Grey stitching, Black with Orange stitching, Cognac with Mocha stitching, Mocha with Night Blue stitching or Oyster with Grey stitching	-	-	-	-	-	-	-	■	-	-	-	■	-	-	-	■	-	-	-	Std
	-	■	-	■	■	-	■	-	■	■	-	-	■	■	-	-	■	■	■	Std
Available in Black with Blue contrast stitching Only with Instrument panel in Sensatec	-	□	-	□	□	-	□	-	□	□	-	-	□	□	-	-	□	□	■	£500
BMW Individual Extended Merino leather Available in Black, Fiona Red / Black, or Ivory White Only with Loudspeaker system – harman/kardon	-	-	-	-	□	-	□	-	-	□	-	-	-	□	-	-	-	□	□	£990
BMW Individual Full Merino leather Available in Black, Fiona Red / Black, or Ivory White Only with Extended Storage / Instrument panel in leather	-	-	-	-	-	-	-	-	-	-	-	-	-	-	-	-	-	-	□	£2,750

* = Exclusively for Saloon models. [^] = Exclusively for Touring models. Only with = these options must be ordered together. ¹ = Exclusively available on SE Pro and Sport Pro models.
² = Not available on 320i models. ³ = Exclusively available on M Sport models.

■ Standard equipment □ Optional equipment - Not available

OPTIONAL EQUIPMENT PRICING.

DIESEL.



	318d SE Pro	318d M Sport	320d SE Pro	320d M Sport	320d M Sport Pro Edition	320d xDrive SE Pro	320d xDrive M Sport	320d xDrive M Sport Pro Edition	330d Sport Pro	330d M Sport	330d M Sport Pro Edition	330d xDrive Sport Pro	330d xDrive M Sport	330d xDrive M Sport Pro Edition	M340d xDrive	Price
--	-------------	--------------	-------------	--------------	--------------------------	--------------------	---------------------	---------------------------------	----------------	--------------	--------------------------	-----------------------	---------------------	---------------------------------	--------------	-------

PAINTWORK

Non-metallic Available in Alpine White or Jet Black ¹	■	■	■	■	-	■	■	-	■	■	-	■	■	-	■	Std
Metallic Available in Black Sapphire, Blue Ridge Mountain ¹ , Glacier Silver ¹ , Melbourne Red ¹ , Mineral Grey, Mineral White, Portimao Blue ² or Phytonic Blue ¹	□	□	□	□	-	□	□	-	-	-	-	-	-	-	-	£670
Available in Dravit Grey, Oxide Grey or Tanzanite Blue	-	-	-	-	■	-	-	■	-	-	■	-	-	■	□	£1,100

UPHOLSTERY

Cloth Available in Anthracite	■	-	■	-	-	■	-	-	-	-	-	-	-	-	-	Std
Sensatec leather Available in Black Only with SE Plus Package	□	-	□	-	-	□	-	-	-	-	-	-	-	-	-	n/a
Vernasca leather – Sport models Available in Black with Grey stitching, Black with Orange stitching, Cognac with Mocha stitching, Mocha with Night Blue stitching or Oyster with Grey stitching	-	-	-	-	-	-	-	-	■	-	-	■	-	-	-	Std
– M Sport models Available in Black with Grey stitching, Cognac with Mocha stitching, Mocha with Night Blue stitching or Oyster with Grey stitching	-	■	-	■	■	-	■	■	-	■	■	-	■	■	■	Std
Available in Black with Blue contrast stitching Only with Instrument panel in Sensatec	-	□	-	□	□	-	□	□	-	□	□	-	□	□	■	£500
BMW Individual Extended Merino leather Available in Black, Fiona Red / Black, or Ivory White Only with Loudspeaker system – harman/kardon	-	-	-	-	□	-	-	□	-	-	□	-	-	□	□	£990
BMW Individual Full Merino leather Available in Black, Fiona Red / Black, or Ivory White Only with Extended Storage / Instrument panel in leather	-	-	-	-	-	-	-	-	-	-	-	-	-	-	□	£2,750

Only with = these options must be ordered together. ¹ = Exclusively available on SE Pro and Sport Pro models. ² = Exclusively available on M Sport models.

■ Standard equipment □ Optional equipment - Not available

PETROL & PLUG-IN HYBRID ELECTRIC VEHICLES.



	318i SE Pro	318i M Sport	320i SE Pro	320i M Sport	320i M Sport Pro Edition	320i xDrive SE Pro*	320i xDrive M Sport*	330i Sport Pro	330i M Sport	330i M Sport Pro Edition [^]	330e SE Pro	330e Sport Pro	330e M Sport	330e M Sport Pro Edition	330e xDrive SE Pro	330e xDrive Sport Pro	330e xDrive M Sport	330e xDrive M Sport Pro Edition	M340i xDrive	Price
--	-------------	--------------	-------------	--------------	--------------------------	---------------------	----------------------	----------------	--------------	---------------------------------------	-------------	----------------	--------------	--------------------------	--------------------	-----------------------	---------------------	---------------------------------	--------------	-------

INTERIOR TRIMS

High-gloss Black	■	-	■	-	-	■	-	■	-	-	■	■	-	-	■	■	-	-	-	Std
Aluminium Tetrakon	-	■	-	■	-	-	■	-	■	-	-	-	■	-	-	-	■	-	■	Std
Aluminium Mesh effect	-	-	-	-	-	-	-	□	-	-	-	□	-	-	-	□	-	-	-	£150
Carbon Fibre	-	□	-	□	-	-	□	-	□	-	-	-	□	-	-	-	□	-	□	£0
Finewood Ash Grey-Brown, High-gloss	□	-	□	-	-	□	-	□	-	-	□	□	-	-	□	□	-	-	-	£300
Finewood Oak grain, open-pored	□	-	□	-	-	□	-	□	-	-	□	□	-	-	□	□	-	-	-	£300
	-	□	-	□	-	-	□	-	□	-	-	-	□	-	-	-	□	-	□	£150

BMW INDIVIDUAL INTERIOR TRIMS

Aluminium Fabric, High-gloss	-	-	-	-	■	-	-	-	-	■	-	-	-	■	-	-	-	■	□	£500
Piano Black	-	□	-	-	-	-	-	-	□	-	-	-	□	-	-	-	□	-	□	£500
	-	-	-	-	-	-	-	-	-	□	-	-	-	□	-	-	-	□	-	£0

STEERING AND CHASSIS

BMW Mobility kit Only with select light alloy wheels	■	■	■	■	-	■	■	■	■	-	■	■	■	-	■	■	■	-	□	£0
M Sport suspension	-	■	-	■	-	-	■	-	■	-	-	-	-	-	-	-	-	-	□	£0
Run-flat tyres Only with select light alloy wheels	-	□	-	□	■	-	□	□	□	■	-	□	□	■	-	□	□	■	■	£0
Space-saver spare wheel* Only with run-flat tyres	□	□	□	□	□	□	□	□	□	□	-	-	-	-	-	-	-	-	□	£190

BMW EFFICIENT DYNAMICS

Active Air Stream Kidney Grille	■	■	■	■	■	■	■	■	■	■	■	■	■	■	■	■	■	■	■	Std
Brake Energy Regeneration	■	■	■	■	■	■	■	■	■	■	■	■	■	■	■	■	■	■	■	Std
ECO PRO mode	■	■	■	■	■	■	■	■	■	■	■	■	■	■	■	■	■	■	■	Std
Electric Power Steering (EPS) with Servotronic	■	■	■	■	■	■	■	■	■	■	■	■	■	■	■	■	■	■	■	Std
High-precision direct injection	■	■	■	■	■	■	■	■	■	■	■	■	■	■	■	■	■	■	■	Std

Certain BMW EfficientDynamics features may be excluded depending on the optional equipment chosen. For full details please contact your local BMW Centre.

* = Exclusively for Saloon models. ^ = Exclusively for Touring models. Only with = these options must be ordered together.

■ Standard equipment □ Optional equipment - Not available

DIESEL.



	318d SE Pro	318d M Sport	320d SE Pro	320d M Sport	320d M Sport Pro Edition	320d xDrive SE Pro	320d xDrive M Sport	320d xDrive M Sport Pro Edition	330d Sport Pro	330d M Sport	330d M Sport Pro Edition	330d xDrive Sport Pro	330d xDrive M Sport	330d xDrive M Sport Pro Edition	M340d xDrive	Price
--	-------------	--------------	-------------	--------------	--------------------------	--------------------	---------------------	---------------------------------	----------------	--------------	--------------------------	-----------------------	---------------------	---------------------------------	--------------	-------

INTERIOR TRIMS

High-gloss Black	■	-	■	-	-	■	-	-	■	-	-	■	-	-	-	Std
Aluminium Tetrakon	-	■	-	■	-	-	■	-	-	■	-	-	■	-	■	Std
Aluminium Mesh effect	-	-	-	-	-	-	-	-	□	-	-	□	-	-	-	£150
Carbon Fibre	-	□	-	□	-	-	□	-	-	□	-	-	□	-	□	£0
Finewood Ash Grey-Brown, High-gloss	-	-	-	-	-	-	-	-	-	-	-	-	-	-	□	£500
Finewood Oak grain, open-pored	□	-	□	-	-	□	-	-	□	-	-	□	-	-	-	£300
	-	□	-	□	-	-	□	-	-	□	-	-	□	-	□	£150
	□	-	□	-	-	□	-	-	□	-	-	□	-	-	-	£300
	-	□	-	□	-	-	□	-	-	□	-	-	□	-	□	£150

BMW INDIVIDUAL INTERIOR TRIMS

Aluminium Fabric, High-gloss	-	-	-	-	■	-	-	■	-	-	■	-	-	■	□	£500
Piano Black	-	□	-	□	-	-	□	-	-	□	-	-	□	-	□	£500
	-	-	-	-	□	-	-	□	-	-	□	-	-	□	-	£0

STEERING AND CHASSIS

BMW Mobility kit Only with select light alloy wheels	■	■	■	■	-	■	■	-	■	■	-	■	■	-	-	£0
M Sport suspension	-	■	-	■	-	-	■	-	-	■	-	-	■	-	-	£0
Run-flat tyres Only with select light alloy wheels	-	□	-	□	■	-	□	■	□	□	■	□	□	■	■	£0
Space-saver spare wheel* Only with run-flat tyres	□	□	□	□	-	□	□	-	□	□	-	□	□	-	□	£190

BMW EFFICIENT DYNAMICS

Active Air Stream Kidney Grille	■	■	■	■	■	■	■	■	■	■	■	■	■	■	■	Std
Brake Energy Regeneration	■	■	■	■	■	■	■	■	■	■	■	■	■	■	■	Std
ECO PRO mode	■	■	■	■	■	■	■	■	■	■	■	■	■	■	■	Std
Electric Power Steering (EPS) with Servotronic	■	■	■	■	■	■	■	■	■	■	■	■	■	■	■	Std

Certain BMW EfficientDynamics features may be excluded depending on the optional equipment chosen. For full details please contact your local BMW Centre.

* = Exclusively for Saloon models. Only with = these options must be ordered together.

■ Standard equipment □ Optional equipment - Not available

PETROL & PLUG-IN HYBRID ELECTRIC VEHICLES.



	318i SE Pro	318i M Sport	320i SE Pro	320i M Sport	320i M Sport Pro Edition	320i xDrive SE Pro*	320i xDrive M Sport*	330i Sport Pro	330i M Sport	330i M Sport Pro Edition^	330e SE Pro	330e Sport Pro	330e M Sport	330e M Sport Pro Edition	330e xDrive SE Pro	330e xDrive Sport Pro	330e xDrive M Sport	330e xDrive M Sport Pro Edition	M340i xDrive	Price
--	-------------	--------------	-------------	--------------	--------------------------	---------------------	----------------------	----------------	--------------	---------------------------	-------------	----------------	--------------	--------------------------	--------------------	-----------------------	---------------------	---------------------------------	--------------	-------

EXTERIOR EQUIPMENT

BMW Individual exterior trim, Satin Aluminium Only with Roof rails, Satin Aluminium^	-	□	-	□	-	-	-	□	□	-	-	□	□	-	-	□	□	-	-	£0
M Carbon Roof* Included in M Carbon Package	-	-	-	-	-	-	-	-	-	-	-	-	-	-	-	-	-	-	□	£2,450
M Sport braking system, High-gloss Red calipers	-	□	-	□	□	-	□	-	□	□	-	-	□	□	-	-	□	□	■	£300
Roof rails, Satin Aluminium^ Only with BMW Individual exterior trim, Satin Aluminium	-	□	-	□	-	-	-	□	□	-	-	□	□	-	-	□	□	-	-	£0
Towbar, fully electric	□	□	□	□	□	□	□	□	□	□	□	□	□	□	□	□	□	□	□	£850

INTERIOR EQUIPMENT

Electric glass sunroof*	□	□	□	□	□	□	□	□	□	-	□	□	□	□	□	□	□	□	□	£950
Extended Storage	□	□	□	□	□	□	□	□	□	□	□	□	□	□	□	□	□	□	□	£190
Instrument panel in leather Only with BMW Individual Full Merino leather	-	-	-	-	-	-	-	-	-	-	-	-	-	-	-	-	-	-	□	n/a
Instrument panel in Sensatec Only with Black Vernasca leather with Blue stitching	-	□	-	□	□	-	□	-	□	□	-	-	□	□	-	-	□	□	■	n/a
Lumbar support, front	-	□	-	□	□	-	□	□	□	□	-	□	□	□	-	□	□	□	□	£265
Panoramic glass sunroof^	□	□	□	□	□	-	-	□	□	□	□	□	□	□	□	□	□	□	□	£1,190
Steering wheel heating	□	□	□	□	□	□	□	□	□	□	□	□	□	□	□	□	□	□	□	£170
Sun protection glass	-	□	-	□	■	-	□	-	□	■	-	-	□	■	-	-	□	■	■	£320

* = Exclusively for Saloon models. ^ = Exclusively for Touring models. Only with = these options must be ordered together.

■ Standard equipment □ Optional equipment - Not available

DIESEL.



	318d SE Pro	318d M Sport	320d SE Pro	320d M Sport	320d M Sport Pro Edition	320d xDrive SE Pro	320d xDrive M Sport	320d xDrive M Sport Pro Edition	330d Sport Pro	330d M Sport	330d M Sport Pro Edition	330d xDrive Sport Pro	330d xDrive M Sport	330d xDrive M Sport Pro Edition	M340d xDrive	Price
--	-------------	--------------	-------------	--------------	--------------------------	--------------------	---------------------	---------------------------------	----------------	--------------	--------------------------	-----------------------	---------------------	---------------------------------	--------------	-------

EXTERIOR EQUIPMENT

BMW Individual exterior trim, Satin Aluminium Only with Roof rails, Satin Aluminium [^]	-	□	-	□	-	-	□	-	□	□	-	□	□	-	-	£0
M Carbon Roof* Included in M Carbon Package	-	-	-	-	-	-	-	-	-	-	-	-	-	-	□	£2,450
M Sport braking system, High-gloss Red calipers	-	□	-	□	□	-	□	□	-	□	□	-	□	□	■	£300
Roof rails, Satin Aluminium [^] Only with BMW Individual exterior trim, Satin Aluminium	-	□	-	□	-	-	□	-	□	□	-	□	□	-	-	£0
Towbar, fully electric	□	□	□	□	□	□	□	□	□	□	□	□	□	□	□	£850

INTERIOR EQUIPMENT

Electric glass sunroof*	□	□	□	□	□	□	□	□	□	□	□	□	□	□	□	£950
Extended Storage	□	□	□	□	□	□	□	□	□	□	□	□	□	□	□	£190
Instrument panel in leather Only with BMW Individual Full Merino leather	-	-	-	-	-	-	-	-	-	-	-	-	-	-	□	n/a
Instrument panel in Sensatec Only with Black Vernasca leather with Blue stitching	-	□	-	□	□	-	□	□	-	□	□	-	□	□	■	n/a
Lumbar support, front	-	□	-	□	□	-	□	□	□	□	□	□	□	□	□	£265
Panoramic glass sunroof [^]	□	□	□	□	□	□	□	□	□	□	□	□	□	□	□	£1,190
Steering wheel heating	□	□	□	□	□	□	□	□	□	□	□	□	□	□	□	£170
Sun protection glass	-	□	-	□	■	-	□	■	-	□	■	-	□	■	■	£320

* = Exclusively for Saloon models. [^] = Exclusively for Touring models. Only with = these options must be ordered together.

■ Standard equipment □ Optional equipment - Not available

PETROL & PLUG-IN HYBRID ELECTRIC VEHICLES.

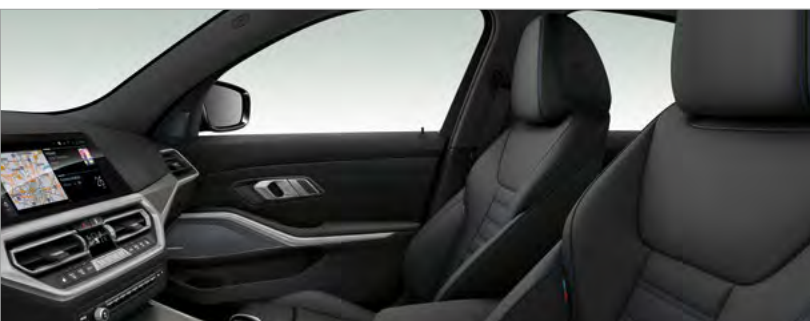

318i SE Pro	318i M Sport	320i SE Pro	320i M Sport	320i M Sport Pro Edition	320i xDrive SE Pro*	320i xDrive M Sport*	330i Sport Pro	330i M Sport	330i M Sport Pro Edition [^]	330e SE Pro	330e Sport Pro	330e M Sport	330e M Sport Pro Edition	330e xDrive SE Pro	330e xDrive Sport Pro	330e xDrive M Sport	330e xDrive M Sport Pro Edition	M340i xDrive	Price
-------------	--------------	-------------	--------------	--------------------------	---------------------	----------------------	----------------	--------------	---------------------------------------	-------------	----------------	--------------	--------------------------	--------------------	-----------------------	---------------------	---------------------------------	--------------	-------

PACKAGES

Packages provide an intelligent selection of individual options at a lower combined price, as well as contributing to the resale value of the vehicle. Further options can still be specified even when a package is chosen.

COMFORT PACKAGE For Saloon, comprises: – Automatic tailgate operation – Comfort Access with smart opener – Extended storage ^{1,2} – Steering wheel heating ¹ For Touring, comprises: – Comfort Access with smart-opener – Extended storage ¹ – Luggage Compartment Package – Steering wheel heating ¹	<input type="checkbox"/>	<input type="checkbox"/>	<input type="checkbox"/>	<input type="checkbox"/>	<input type="checkbox"/>	<input type="checkbox"/>	<input type="checkbox"/>	<input type="checkbox"/>	-	<input type="checkbox"/>	<input type="checkbox"/>	<input type="checkbox"/>	<input type="checkbox"/>	<input type="checkbox"/>	<input type="checkbox"/>	<input type="checkbox"/>	<input type="checkbox"/>	<input type="checkbox"/>	£990	
COMFORT PLUS PACKAGE Comprises: – Comfort Package – Seat adjustment- front, electric with driver memory – Lumbar support, front ¹	-	<input type="checkbox"/>	-	<input type="checkbox"/>	<input type="checkbox"/>	-	<input type="checkbox"/>	<input type="checkbox"/>	<input type="checkbox"/>	-	<input type="checkbox"/>	<input type="checkbox"/>	<input type="checkbox"/>	-	<input type="checkbox"/>	<input type="checkbox"/>	<input type="checkbox"/>	<input type="checkbox"/>	£1,950	
M CARBON PACKAGE* Comprises: – M Carbon Roof – Interior trim, Carbon Fibre	-	-	-	-	-	-	-	-	-	-	-	-	-	-	-	-	-	<input type="checkbox"/>	£2,500	
M SPORT PRO PACKAGE Comprises: – 19" M Double-spoke style 791 M wheels, Bicolour Jet Black with mixed tyres – Adaptive M suspension – BMW Individual High-gloss Shadowline exterior trim with extended contents – BMW Individual lights Shadowline – M rear spoiler* – M seat belts – Sun protection glass Differing content: – M Sport braking system – M Sport differential – Variable Sport Steering	-	-	-	<input type="checkbox"/>	■	-	<input type="checkbox"/>	-	<input type="checkbox"/>	■	-	-	<input type="checkbox"/>	■	-	-	<input type="checkbox"/>	■	-	£2,500
M TECHNOLOGY PACKAGE*	-	-	-	-	-	-	-	-	-	-	-	-	-	-	-	-	-	-	<input type="checkbox"/>	£300

* = Exclusively for Saloon models. ^ = Exclusively for Touring models. ¹ = Available as a single option.

■ Standard equipment □ Optional equipment - Not available

DIESEL.

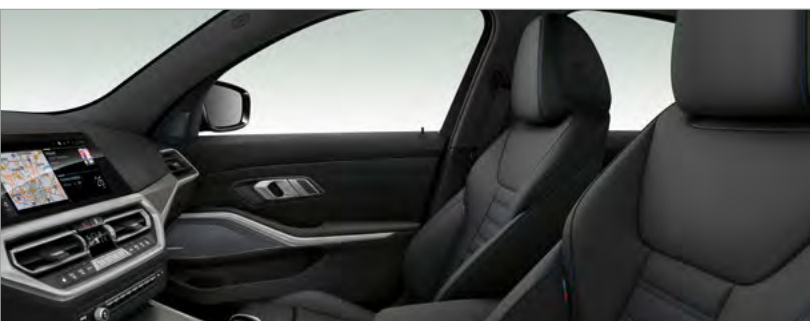

318d SE Pro	318d M Sport	320d SE Pro	320d M Sport	320d M Sport Pro Edition	320d xDrive SE Pro	320d xDrive M Sport	320d xDrive M Sport Pro Edition	330d Sport Pro	330d M Sport	330d M Sport Pro Edition	330d xDrive Sport Pro	330d xDrive M Sport	330d xDrive M Sport Pro Edition	M340d xDrive	Price
-------------	--------------	-------------	--------------	--------------------------	--------------------	---------------------	---------------------------------	----------------	--------------	--------------------------	-----------------------	---------------------	---------------------------------	--------------	-------

PACKAGES

Packages provide an intelligent selection of individual options at a lower combined price, as well as contributing to the resale value of the vehicle. Further options can still be specified even when a package is chosen.

COMFORT PACKAGE For Saloon, comprises: – Automatic tailgate operation – Comfort Access with smart opener – Extended storage ^{1,2} – Steering wheel heating ¹ For Touring, comprises: – Comfort Access with smart-opener – Extended storage ¹ – Luggage Compartment Package – Steering wheel heating ¹	<input type="checkbox"/>	<input type="checkbox"/>	<input type="checkbox"/>	<input type="checkbox"/>	<input type="checkbox"/>	<input type="checkbox"/>	<input type="checkbox"/>	<input type="checkbox"/>	<input type="checkbox"/>	<input type="checkbox"/>	<input type="checkbox"/>	<input type="checkbox"/>	<input type="checkbox"/>	<input type="checkbox"/>	£990	
COMFORT PLUS PACKAGE Comprises: – Comfort Package – Seat adjustment- front, electric with driver memory – Lumbar support, front ¹	-	<input type="checkbox"/>	-	<input type="checkbox"/>	<input type="checkbox"/>	-	<input type="checkbox"/>	<input type="checkbox"/>	<input type="checkbox"/>	<input type="checkbox"/>	<input type="checkbox"/>	<input type="checkbox"/>	<input type="checkbox"/>	<input type="checkbox"/>	£1,950	
M CARBON PACKAGE* Comprises: – M Carbon Roof – Interior trim, Carbon Fibre	-	-	-	-	-	-	-	-	-	-	-	-	-	<input type="checkbox"/>	£2,500	
M SPORT PRO PACKAGE Comprises: – 19" M Double-spoke style 791 M wheels, Bicolour Jet Black with mixed tyres – Adaptive M suspension – BMW Individual High-gloss Shadowline exterior trim with extended contents – BMW Individual lights Shadowline – M rear spoiler* – M seat belts – Sun protection glass Differing content: – M Sport braking system – M Sport differential – Variable Sport Steering	-	<input type="checkbox"/>	-	<input type="checkbox"/>	■	-	<input type="checkbox"/>	■	-	<input type="checkbox"/>	■	-	<input type="checkbox"/>	■	-	£2,500
	-	<input type="checkbox"/>	-	<input type="checkbox"/>	■	-	<input type="checkbox"/>	■	-	■	■	-	■	■	■	
	-	-	-	-	-	-	-	-	<input type="checkbox"/>	■	-	<input type="checkbox"/>	■	■	■	
	-	■	-	■	■	-	■	■	-	■	■	-	■	■	■	

* = Exclusively for Saloon models. ¹ = Available as a single option.

■ Standard equipment □ Optional equipment - Not available

PETROL & PLUG-IN HYBRID ELECTRIC VEHICLES.

	318i SE Pro	318i M Sport	320i SE Pro	320i M Sport	320i M Sport Pro Edition	320i xDrive SE Pro*	320i xDrive M Sport*	330i Sport Pro	330i M Sport	330i M Sport Pro Edition^	330e SE Pro	330e Sport Pro	330e M Sport	330e M Sport Pro Edition	330e xDrive SE Pro	330e xDrive Sport Pro	330e xDrive M Sport	330e xDrive M Sport Pro Edition	M340i xDrive	Price
--	-------------	--------------	-------------	--------------	--------------------------	---------------------	----------------------	----------------	--------------	---------------------------	-------------	----------------	--------------	--------------------------	--------------------	-----------------------	---------------------	---------------------------------	--------------	-------

PACKAGES (CONT.)

<p>SE PLUS PACKAGE Comprises: – Black Sensatec leather upholstery – Heated seats, front</p> <p>Differing content: – Larger fuel tank¹ (Increased to 59 litres)</p>	□	-	□	-	-	□	-	-	-	-	□	-	-	-	□	-	-	-	-	£650
<p>SHADOWLINE PLUS Comprises: – 19" M Double-spoke style 791 M wheels, Jet Black with mixed tyres – Extended High-gloss Shadowline exterior trim – Mirror caps, Black – BMW Individual lights Shadowline</p>	-	-	-	-	-	-	-	-	-	-	-	-	-	-	-	-	-	-	■	£750
<p>TECHNOLOGY PACKAGE – BMW Gesture Control – Enhanced Bluetooth with wireless charging – Head-up Display – Loudspeaker system – harman/kardon¹ – WiFi hotspot preparation²</p>	□	□	□	□	□	□	□	□	□	□	□	□	□	□	□	□	□	□	□	£1,900
<p>TECHNOLOGY PLUS PACKAGE Comprises: – Technology Package – Parking Assistant Plus – Drive Recorder – Driving Assistant Plus</p>	□	□	□	□	□	□	□	□	□	□	□	□	□	□	□	□	□	□	□	£3,650
<p>VISIBILITY PACKAGE Comprises: – BMW Laserlights – High-beam Assistant</p>	□	□	□	□	□	□	□	□	□	□	□	□	□	□	□	□	□	□	□	£1,500

* = Exclusively for Saloon models. ^ = Exclusively for Touring models. ¹ = Available as a single option. ² = Data subscription costs apply and must be purchased separately.

■ Standard equipment □ Optional equipment - Not available

DIESEL.

	318d SE Pro	318d M Sport	320d SE Pro	320d M Sport	320d M Sport Pro Edition	320d xDrive SE Pro	320d xDrive M Sport	320d xDrive M Sport Pro Edition	330d Sport Pro	330d M Sport	330d M Sport Pro Edition	330d xDrive Sport Pro	330d xDrive M Sport	330d xDrive M Sport Pro Edition	M340d xDrive	Price
--	-------------	--------------	-------------	--------------	--------------------------	--------------------	---------------------	---------------------------------	----------------	--------------	--------------------------	-----------------------	---------------------	---------------------------------	--------------	-------

PACKAGES (CONT.)

<p>SE PLUS PACKAGE Comprises: – Black Sensatec leather upholstery – Heated seats, front</p> <p>Differing content: – Larger fuel tank¹ (Increased to 59 litres)</p>	□	-	□	-	-	□	-	-	-	-	-	-	-	-	-	£650
<p>SHADOWLINE PLUS Comprises: – 19" M Double-spoke style 791 M wheels, Jet Black with mixed tyres – Extended High-gloss Shadowline exterior trim – Mirror caps, Black – BMW Individual lights Shadowline</p>	-	-	-	-	-	-	-	-	-	-	-	-	-	-	□	£750
<p>TECHNOLOGY PACKAGE – BMW Gesture Control – Enhanced Bluetooth with wireless charging – Head-up Display – Loudspeaker system – harman/kardon¹ – WiFi hotspot preparation²</p>	□	□	□	□	□	□	□	□	□	□	□	□	□	□	□	£1,900
<p>TECHNOLOGY PLUS PACKAGE Comprises: – Technology Package – Parking Assistant Plus – Drive Recorder – Driving Assistant Plus</p>	□	□	□	□	□	□	□	□	□	□	□	□	□	□	□	£3,650
<p>VISIBILITY PACKAGE Comprises: – BMW Laserlights – High-beam Assistant</p>	□	□	□	□	□	□	□	□	□	□	□	□	□	□	□	£1,500

¹ = Available as a single option. ² = Data subscription costs apply and must be purchased separately.

■ Standard equipment □ Optional equipment - Not available

PETROL & PLUG-IN HYBRID ELECTRIC VEHICLES.



	318i SE Pro	318i M Sport	320i SE Pro	320i M Sport	320i M Sport Pro Edition	320i xDrive SE Pro*	320i xDrive M Sport*	330i Sport Pro	330i M Sport	330i M Sport Pro Edition^	330e SE Pro	330e Sport Pro	330e M Sport	330e M Sport Pro Edition	330e xDrive SE Pro	330e xDrive Sport Pro	330e xDrive M Sport	330e xDrive M Sport Pro Edition	M340i xDrive	Price
--	-------------	--------------	-------------	--------------	--------------------------	---------------------	----------------------	----------------	--------------	---------------------------	-------------	----------------	--------------	--------------------------	--------------------	-----------------------	---------------------	---------------------------------	--------------	-------

SAFETY & TECHNOLOGY

Active Guard Plus Comprises: – Front collision warning with brake intervention – Lane Departure warning – Speed Limit Assist	■	■	■	■	■	■	■	■	■	■	■	■	■	■	■	■	■	■	■	Std
Drive Recorder ¹ Comprises: – Event recorder – Crash recorder Only with Parking Assistant Plus	□	□	□	□	□	□	□	□	□	□	□	□	□	□	□	□	□	□	□	n/a
Driving Assistant Professional Comprises: – Active Cruise Control with approach control – Active Lane guidance – Automatic Speed Limit Assist – Crossing traffic warning, front – Crossroads warning and city braking function – Evasion aid – Lane Keeping Assistant with Active side collision protection – Steering and Lane Control Assistant – Wrong-way warning Only with Automatic transmission / Sport automatic transmission Included in Technology Plus Package	□	□	□	□	□	□	□	□	□	□	□	□	□	□	□	□	□	□	□	£1,250
Larger fuel tank (59 litres)	□	■	■	■	■	□	■	■	■	■	-	-	-	-	-	-	-	-	■	£40
Parking Assistant Comprises: – Lateral parking aid – Park Distance Control (PDC), front and rear – Parking Assistant – Rear-view camera – Reversing Assistant	■	■	■	■	■	■	■	■	■	■	■	■	■	■	■	■	■	■	■	Std
Parking Assistant Plus Comprises all functionality of Parking Assistant, plus: – Remote 3D View – Surround View Only with Drive Recorder Included in Technology Plus Package	□	□	□	□	□	□	□	□	□	□	□	□	□	□	□	□	□	□	□	£650

* = Exclusively for Saloon models. ^ = Exclusively for Touring models. Only with = these options must be ordered together. Not with = these options are not available for ordering together
¹ = Please note that heavy accidents with hard disc damages or camera damages are owing to circumstances where videos may not be recorded or saved.

■ Standard equipment □ Optional equipment - Not available

DIESEL.



	318d SE Pro	318d M Sport	320d SE Pro	320d M Sport	320d M Sport Pro Edition	320d xDrive SE Pro	320d xDrive M Sport	320d xDrive M Sport Pro Edition	330d Sport Pro	330d M Sport	330d M Sport Pro Edition	330d xDrive Sport Pro	330d xDrive M Sport	330d xDrive M Sport Pro Edition	M340d xDrive	Price
--	-------------	--------------	-------------	--------------	--------------------------	--------------------	---------------------	---------------------------------	----------------	--------------	--------------------------	-----------------------	---------------------	---------------------------------	--------------	-------

SAFETY & TECHNOLOGY

Active Guard Plus Comprises: – Front collision warning with brake intervention – Lane Departure warning – Speed Limit Assist	■	■	■	■	■	■	■	■	■	■	■	■	■	■	■	Std
Automatic transmission*	□	□	-	-	-	-	-	-	-	-	-	-	-	-	-	£1,550
Drive Recorder ¹ Comprises: – Event recorder – Crash recorder Only with Parking Assistant Plus	□	□	□	□	□	□	□	□	□	□	□	□	□	□	□	n/a
Driving Assistant Professional Comprises: – Active Cruise Control with approach control – Active Lane guidance – Automatic Speed Limit Assist – Crossing traffic warning, front – Crossroads warning and city braking function – Evasion aid – Lane Keeping Assistant with Active side collision protection – Steering and Lane Control Assistant – Wrong-way warning Only with Automatic transmission / Sport automatic transmission Included in Technology Plus Package	□	□	□	□	□	□	□	□	□	□	□	□	□	□	□	£1,250
Larger fuel tank (59 litres)	□	■	□	■	■	□	■	■	■	■	■	■	■	■	■	£40
Parking Assistant Comprises: – Lateral parking aid – Park Distance Control (PDC), front and rear – Parking Assistant – Rear-view camera – Reversing Assistant	■	■	■	■	■	■	■	■	■	■	■	■	■	■	■	Std
Parking Assistant Plus Comprises all functionality of Parking Assistant, plus: – Remote 3D View – Surround View Only with Drive Recorder Included in Technology Plus Package	□	□	□	□	□	□	□	□	□	□	□	□	□	□	□	£650

Only with = these options must be ordered together. Not with = these options are not available for ordering together ¹ = Please note that heavy accidents with hard disc damages or camera damages are owing to circumstances where videos may not be recorded or saved.

■ Standard equipment □ Optional equipment - Not available

PETROL & PLUG-IN HYBRID ELECTRIC VEHICLES.



318i SE Pro	318i M Sport	320i SE Pro	320i M Sport	320i M Sport Pro Edition	320i xDrive SE Pro*	320i xDrive M Sport*	330i Sport Pro	330i M Sport	330i M Sport Pro Edition^	330e SE Pro	330e Sport Pro	330e M Sport	330e M Sport Pro Edition	330e xDrive SE Pro	330e xDrive Sport Pro	330e xDrive M Sport	330e xDrive M Sport Pro Edition	M340i xDrive	Price
-------------	--------------	-------------	--------------	--------------------------	---------------------	----------------------	----------------	--------------	---------------------------	-------------	----------------	--------------	--------------------------	--------------------	-----------------------	---------------------	---------------------------------	--------------	-------

AUDIO & COMMUNICATION

BMW Emergency Call ¹	■	■	■	■	■	■	■	■	■	■	■	■	■	■	■	■	■	■	Std
BMW Live Cockpit Professional Comprises: – 10.25" Control Display with Touch Functionality – 12.3" Digital Instrument Display – BMW Intelligent Personal Assistant ² – BMW Operating System 7.0 – iDrive Controller with Touch Function – Intelligent Functionalities ² – Remote Software Upgrade ² For further details, see BMW ConnectedDrive	■	■	■	■	■	■	■	■	■	■	■	■	■	■	■	■	■	■	Std
BMW Online Services ^{2,3} – BMW Apps – BMW Online Services – Last State Call ¹ – USB and Over-the-air Map Updates	■	■	■	■	■	■	■	■	■	■	■	■	■	■	■	■	■	■	Std

* = Exclusively for Saloon models. ^ = Exclusively for Touring models. ¹ = Available and active without runtime limitations. Usage cannot be guaranteed permanently due to potential future technical developments (of the Service availability and/or Smartphone compatibility/operating systems). ² = Active for 3 years, renewable thereafter at an additional cost. ³ = Requires a free BMW ConnectedDrive account.

■ Standard equipment □ Optional equipment - Not available

DIESEL.



	318d SE Pro	318d M Sport	320d SE Pro	320d M Sport	320d M Sport Pro Edition	320d xDrive SE Pro	320d xDrive M Sport	320d xDrive M Sport Pro Edition	330d Sport Pro	330d M Sport	330d M Sport Pro Edition	330d xDrive Sport Pro	330d xDrive M Sport	330d xDrive M Sport Pro Edition	M340d xDrive	Price
--	-------------	--------------	-------------	--------------	--------------------------	--------------------	---------------------	---------------------------------	----------------	--------------	--------------------------	-----------------------	---------------------	---------------------------------	--------------	-------

AUDIO & COMMUNICATION

BMW Emergency Call ¹	■	■	■	■	■	■	■	■	■	■	■	■	■	■	■	Std
BMW Live Cockpit Professional Comprises: – 10.25" Control Display with Touch Functionality – 12.3" Digital Instrument Display – BMW Intelligent Personal Assistant ² – BMW Operating System 7.0 – iDrive Controller with Touch Function – Intelligent Functionalities ² – Remote Software Upgrade ² For further details, see BMW ConnectedDrive	■	■	■	■	■	■	■	■	■	■	■	■	■	■	■	Std
BMW Online Services ^{2,3} – BMW Apps – BMW Online Services – Last State Call ¹ – USB and Over-the-air Map Updates	■	■	■	■	■	■	■	■	■	■	■	■	■	■	■	Std

¹ = Available and active without runtime limitations. Usage cannot be guaranteed permanently due to potential future technical developments (of the Service availability and/or Smartphone compatibility/operating systems). ² = Active for 3 years, renewable thereafter at an additional cost. ³ = Requires a free BMW ConnectedDrive account.

■ Standard equipment □ Optional equipment - Not available

PETROL & PLUG-IN HYBRID ELECTRIC VEHICLES.



	318i SE Pro	318i M Sport	320i SE Pro	320i M Sport	320i M Sport Pro Edition	320i xDrive SE Pro*	320i xDrive M Sport*	330i Sport Pro	330i M Sport	330i M Sport Pro Edition^	330e SE Pro	330e Sport Pro	330e M Sport	330e M Sport Pro Edition	330e xDrive SE Pro	330e xDrive Sport Pro	330e xDrive M Sport	330e xDrive M Sport Pro Edition	M340i xDrive	Price
--	-------------	--------------	-------------	--------------	--------------------------	---------------------	----------------------	----------------	--------------	---------------------------	-------------	----------------	--------------	--------------------------	--------------------	-----------------------	---------------------	---------------------------------	--------------	-------

AUDIO & COMMUNICATION (CONT.)

BMW TeleServices ¹	■	■	■	■	■	■	■	■	■	■	■	■	■	■	■	■	■	■	■	Std
Connected Package Professional ^{2,3} Comprises: – BMW Maps – Concierge Services – Connected Charging – Connected Music – Connected Parking – Connected Teaser ^{4,5} – Real Time Traffic Information – Remote Services – Smartphone Integration ^{1,6} For further details, see BMW ConnectedDrive	■	■	■	■	■	■	■	■	■	■	■	■	■	■	■	■	■	■	■	Std
Enhanced Bluetooth with wireless charging	□	□	□	□	□	□	□	□	□	□	□	□	□	□	□	□	□	□	□	£350
IconicSounds Sport ^{2,7}	-	-	□	□	□	□	□	-	-	-	-	-	-	-	-	-	-	-	-	n/a
Loudspeaker system – harman/kardon	□	□	□	□	□	-	-	□	□	□	□	□	□	□	□	□	□	□	□	£820

* = Exclusively for Saloon models. ^ = Exclusively for Touring models. ¹ = Available and active without runtime limitations. Usage cannot be guaranteed permanently due to potential future technical developments (of the Service availability and/or Smartphone compatibility/operating systems). ² = Requires a free BMW ConnectedDrive account. ³ = Active for 3 years, renewable thereafter at an additional cost. ⁴ = Available and active for three months. Can be extended or renewed thereafter at an extra cost. ⁵ = Includes BMW Music. For further details, see [BMW ConnectedDrive](#). ⁶ = Functions using a data connection will use data from the SIM card in the phone. Additional data charges may be applied by the mobile network provider. Compatibility and functions may vary due to the make and model year of the phone and the version of software installed on it. ⁷ = Available for purchase via the BMW ConnectedDrive store after vehicle production.

DIESEL.



	318d SE Pro	318d M Sport	320d SE Pro	320d M Sport	320d M Sport Pro Edition	320d xDrive SE Pro	320d xDrive M Sport	320d xDrive M Sport Pro Edition	330d Sport Pro	330d M Sport	330d M Sport Pro Edition	330d xDrive Sport Pro	330d xDrive M Sport	330d xDrive M Sport Pro Edition	M340d xDrive	Price
--	-------------	--------------	-------------	--------------	--------------------------	--------------------	---------------------	---------------------------------	----------------	--------------	--------------------------	-----------------------	---------------------	---------------------------------	--------------	-------

AUDIO & COMMUNICATION (CONT.)

BMW TeleServices ¹	■	■	■	■	■	■	■	■	■	■	■	■	■	■	■	Std
Connected Package Professional ^{2,3} Comprises: – BMW Maps – Concierge Services – Connected Charging – Connected Music – Connected Parking – Connected Teaser ^{4,5} – Real Time Traffic Information – Remote Services – Smartphone Integration ^{1,6} For further details, see BMW ConnectedDrive	■	■	■	■	■	■	■	■	■	■	■	■	■	■	■	Std
Enhanced Bluetooth with wireless charging	□	□	□	□	□	□	□	□	□	□	□	□	□	□	□	£350
Loudspeaker system – harman/kardon	□	□	□	□	□	□	□	□	□	□	□	□	□	□	□	£820





¹ = Available and active without runtime limitations. Usage cannot be guaranteed permanently due to potential future technical developments (of the Service availability and/or Smartphone compatibility/operating systems). ² = Requires a free BMW ConnectedDrive account. ³ = Active for 3 years, renewable thereafter at an additional cost. ⁴ = Available and active for three months. Can be extended or renewed thereafter at an extra cost. ⁵ = Includes BMW Music. For further details, see [BMW ConnectedDrive](#). ⁶ = Functions using a data connection will use data from the SIM card in the phone. Additional data charges may be applied by the mobile network provider. Compatibility and functions may vary due to the make and model year of the phone and the version of software installed on it. ⁷ = Available for purchase via the BMW ConnectedDrive store after vehicle production.

PETROL & PLUG-IN HYBRID ELECTRIC VEHICLES.



318i SE Pro	318i M Sport	320i SE Pro	320i M Sport	320i M Sport Pro Edition	320i xDrive SE Pro*	320i xDrive M Sport*	330i Sport Pro	330i M Sport	330i M Sport Pro Edition [^]	330e SE Pro	330e Sport Pro	330e M Sport	330e M Sport Pro Edition	330e xDrive SE Pro	330e xDrive Sport Pro	330e xDrive M Sport	330e xDrive M Sport Pro Edition	M340i xDrive	Snow chains	Run-flat tyres ¹	Price
-------------	--------------	-------------	--------------	--------------------------	---------------------	----------------------	----------------	--------------	---------------------------------------	-------------	----------------	--------------	--------------------------	--------------------	-----------------------	---------------------	---------------------------------	--------------	-------------	-----------------------------	-------

LIGHT ALLOY WHEELS

	17" V-spoke style 778	■	-	■	-	-	■	-	-	-	-	■	-	-	-	-	-	-	□	-	Std
	18" Double-spoke style 782, Bicolour Orbit Grey	□	-	□	-	-	□	-	-	-	-	-	-	-	-	-	-	-	□	-	£750
	18" V-spoke style 780, Bicolour Orbit Grey	-	-	-	-	-	-	■	-	-	-	-	-	-	-	-	-	-	□	-	Std
	18" V-spoke style 780, Bicolour Orbit Grey	-	-	-	-	-	-	-	-	-	■	-	-	-	■	-	-	-	-	-	Std
	18" M Double-spoke style 790 M, Bicolour Orbit Grey	-	■	-	■	-	-	■	-	■	-	■	-	-	-	■	-	□	-	-	£0

* = Exclusively for Saloon models. [^] = Exclusively for Touring models. See [Wheels & Tyres](#) for further details. ¹ = Mobility kit is standard where run-flat tyres are not available.





■ Standard equipment □ Optional equipment - Not available

DIESEL.



318d SE Pro	318d M Sport	320d SE Pro	320d M Sport	320d M Sport Pro Edition	320d xDrive SE Pro	320d xDrive M Sport	320d xDrive M Sport Pro Edition	330d Sport Pro	330d M Sport	330d M Sport Pro Edition	330d xDrive Sport Pro	330d xDrive M Sport	330d xDrive M Sport Pro Edition	M340d xDrive	Snow chains	Run-flat tyres ¹	Price
-------------	--------------	-------------	--------------	--------------------------	--------------------	---------------------	---------------------------------	----------------	--------------	--------------------------	-----------------------	---------------------	---------------------------------	--------------	-------------	-----------------------------	-------

LIGHT ALLOY WHEELS

	17" V-spoke style 778	■	-	■	-	-	■	-	-	-	-	-	-	-	□	-	Std
	18" Double-spoke style 782, Bicolour Orbit Grey	□	-	□	-	-	□	-	-	-	-	-	-	-	□	-	£750
	18" V-spoke style 780, Bicolour Orbit Grey	-	-	-	-	-	-	■	-	-	■	-	-	-	□	-	Std
	18" V-spoke style 780, Bicolour Orbit Grey	-	-	-	-	-	-	-	-	-	-	-	-	-	-	-	Std
	18" M Double-spoke style 790 M, Bicolour Orbit Grey	-	■	-	■	-	-	■	-	-	-	■	-	-	-	-	Std

See [Wheels & Tyres](#) for further details. ¹ = Mobility kit is standard where run-flat tyres are not available.

■ Standard equipment □ Optional equipment - Not available

PETROL & PLUG-IN HYBRID ELECTRIC VEHICLES.



318i SE Pro	318i M Sport	320i SE Pro	320i M Sport	320i M Sport Pro Edition	320i xDrive SE Pro*	320i xDrive M Sport*	330i Sport Pro	330i M Sport	330i M Sport Pro Edition [^]	330e SE Pro	330e Sport Pro	330e M Sport	330e M Sport Pro Edition	330e xDrive SE Pro	330e xDrive Sport Pro	330e xDrive M Sport	330e xDrive M Sport Pro Edition	M340i xDrive	Snow chains	Run-flat tyres ¹	Price
-------------	--------------	-------------	--------------	--------------------------	---------------------	----------------------	----------------	--------------	---------------------------------------	-------------	----------------	--------------	--------------------------	--------------------	-----------------------	---------------------	---------------------------------	--------------	-------------	-----------------------------	-------

LIGHT ALLOY WHEELS (CONT.)

	19" M Double-spoke style 791 M, Bicolour Jet Black	-	-	-	-	□	-	-	-	□	-	-	-	□	-	-	-	□	-	-	■	£0
	Only with M Sport Pro Package (M Sport models)	-	-	-	□	-	-	□	-	□	-	-	-	□	-	-	-	□	-	-	-	■
	19" BMW Individual Double-spoke style 793, Bicolour Orbit Grey	-	□	-	□	-	-	□	□	□	-	-	□	-	-	□	□	-	-	-	■	£750
	Not with M Sport Pro Package	-	-	-	-	■	-	-	-	■	-	-	-	■	-	-	-	-	■	□	-	-
	19" M Double-spoke style 791 M, Jet Black	-	-	-	-	-	-	-	-	-	-	-	-	-	-	-	-	-	-	-	-	n/a
	Only with Shadowline Plus Package	-	-	-	-	-	-	-	-	-	-	-	-	-	-	-	-	-	-	■	-	-
	19" M Double-spoke style 792 M, Bicolour Cerium Grey	-	-	-	-	-	-	-	-	-	-	-	-	-	-	-	-	-	-	-	-	Std
		-	-	-	-	-	-	-	-	-	-	-	-	-	-	-	-	-	-	-	-	-

* = Exclusively for Saloon models. ^ = Exclusively for Touring models. See [Wheels & Tyres](#) for further details. Only with = these options must be ordered together. Not with = these options are not available for ordering together. ¹ = Mobility kit is standard where run-flat tyres are not available.





■ Standard equipment □ Optional equipment - Not available

DIESEL.



318d SE Pro	318d M Sport	320d SE Pro	320d M Sport	320d M Sport Pro Edition	320d xDrive SE Pro	320d xDrive M Sport	320d xDrive M Sport Pro Edition	330d Sport Pro	330d M Sport	330d M Sport Pro Edition	330d xDrive Sport Pro	330d xDrive M Sport	330d xDrive M Sport Pro Edition	M340d xDrive	Snow chains	Run-flat tyres ¹	Price
-------------	--------------	-------------	--------------	--------------------------	--------------------	---------------------	---------------------------------	----------------	--------------	--------------------------	-----------------------	---------------------	---------------------------------	--------------	-------------	-----------------------------	-------

LIGHT ALLOY WHEELS (CONT.)

 <p>19" M Double-spoke style 791 M, Bicolour Jet Black</p>	-	-	-	-	□	-	-	□	-	-	□	-	-	□	-	-	■	£0
	-	□	-	□	-	-	□	-	-	□	-	-	□	-	-	-	■	n/a
 <p>19" BMW Individual Double-spoke style 793, Bicolour Orbit Grey</p> <p>Only with M Sport Pro Package (M Sport models)</p>	-	□	-	□	-	-	□	-	□	□	-	□	□	-	-	-	■	£750
 <p>19" M Double-spoke style 791 M, Jet Black</p> <p>Not with M Sport Pro Package</p>	-	-	-	-	■	-	-	■	-	-	■	-	-	■	□	-	-	n/a
 <p>19" M Double-spoke style 792 M, Bicolour Cerium Grey</p> <p>Only with Shadowline Plus Package</p>	-	-	-	-	-	-	-	-	-	-	-	-	-	-	■	-	-	Std

See [Wheels & Tyres](#) for further details. Only with = these options must be ordered together. Not with = these options are not available for ordering together.
¹ = Mobility kit is standard where run-flat tyres are not available.

■ Standard equipment □ Optional equipment - Not available

PETROL & PLUG-IN HYBRID ELECTRIC VEHICLES.



330e SE Pro	330e Sport Pro	330e M Sport	330e M Sport Pro Edition	330e xDrive SE Pro	330e xDrive Sport Pro	330e xDrive M Sport	330e xDrive M Sport Pro Edition	Price
-------------	----------------	--------------	--------------------------	--------------------	-----------------------	---------------------	---------------------------------	-------

360° ELECTRIC

Digital Charging Service – 12 months subscription ¹	■	■	■	■	■	■	■	■	n/a
Home charging: BMW i Wallbox Connect (32 Amp) with Standard Installation ²	□	□	□	□	□	□	□	□	From £975*
Public Charging: BMW i AC Rapid Charge Cable (5 metre length) – Max 32 Amp 3-phase public charging cable, Type 2 connectors	■	■	■	■	■	■	■	■	n/a
Public Charging: BMW i AC Fast Charge Cable (8 metre length) – Max 32 Amp 1-phase public charging cable, Type 2 connectors	□	□	□	□	□	□	□	□	£195
Public charging: ChargeNow – Pay as you go charging ³	□	□	□	□	□	□	□	□	£7.85 per month
Assistance Services – BMW i Mobile Care – Battery Warranty – Vehicle Warranty	■	■	■	■	■	■	■	■	n/a



* = Subject to OLEV subsidy and qualification which may be liable to change, for further details please speak to your local BMW Centre. For more information about Plug-In Hybrid Electric Vehicles please visit [here](#). ¹ = 12 months subscription from production date only, renewable thereafter for £45 per annum via the ConnectedDrive Store. ² = Includes 3 year warranty. ³ = Available as a stand alone service. Terms and Conditions apply, find out more [here](#). The design of the charging cable may vary from image shown. Content correct at time of publishing. Prices subject to change.

■ Standard equipment □ Optional equipment - Not available

DIMENSIONS.

THE BMW 3 SERIES SALOON.

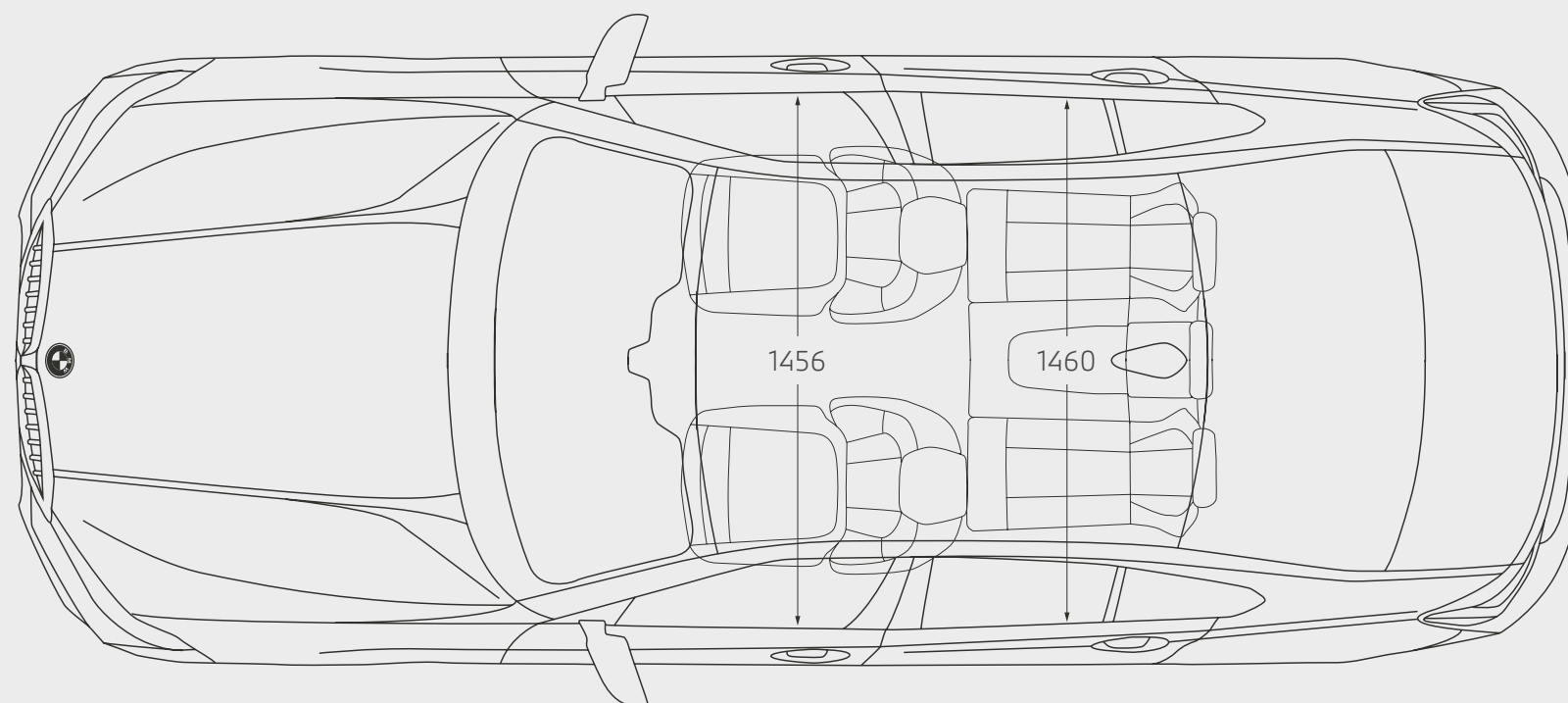
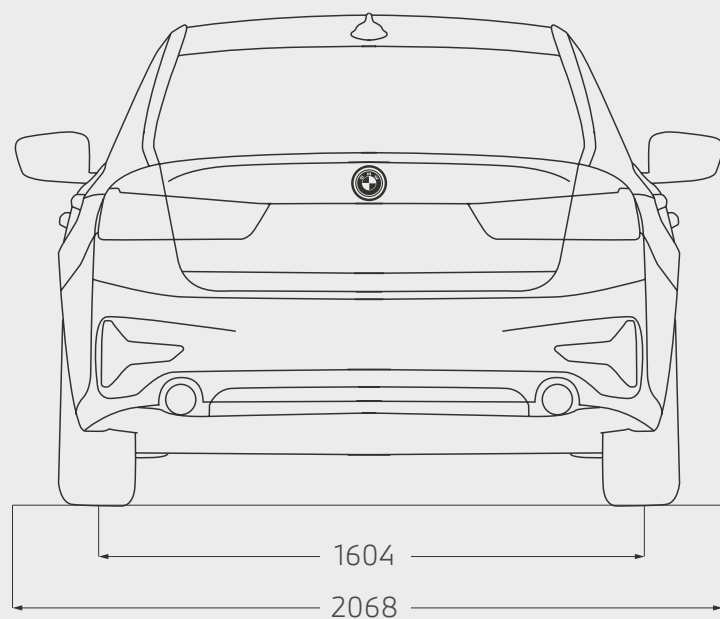
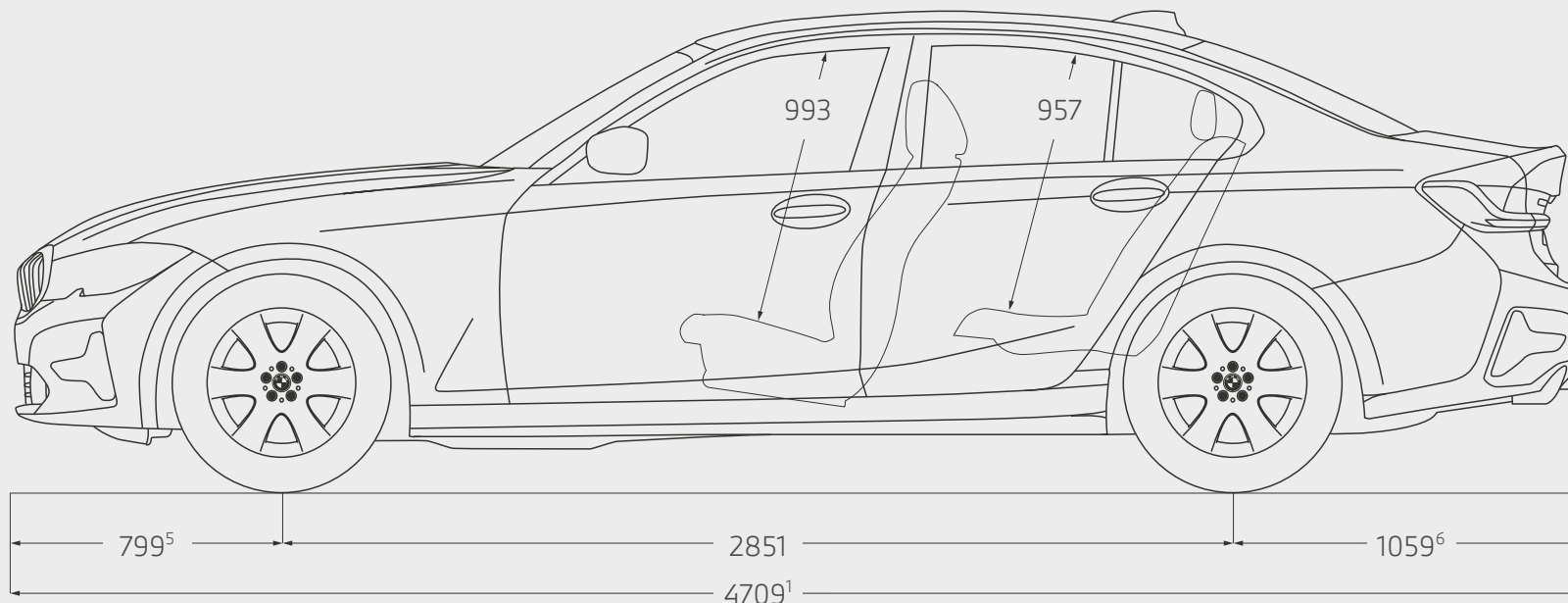
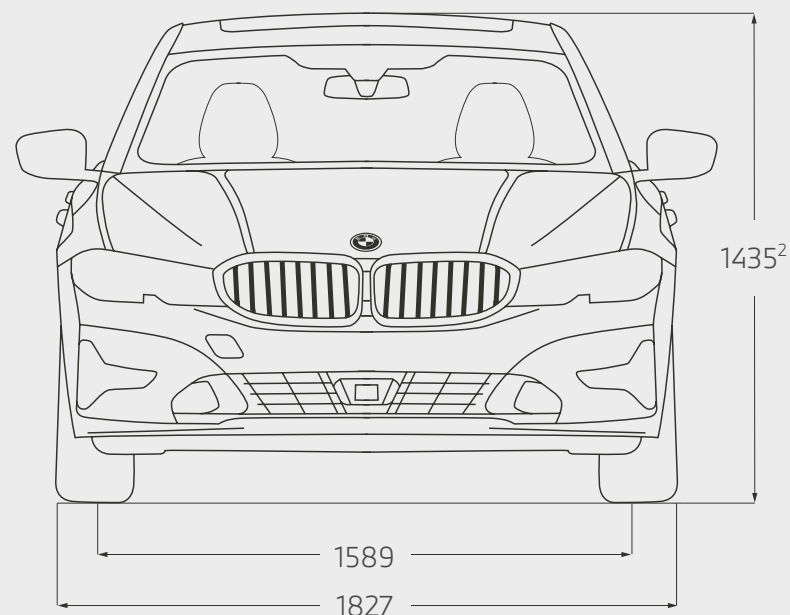

Length (mm)	4709 ¹	Height (mm)	1435 ²	Number of seats	5	Turning circle (m)	11.4 ³
Width (mm)	1827	Width including mirrors (mm) (Driver / Passenger)	2068 (1040 / 1028)	Wheelbase (mm)	2851	Luggage capacity (litre)	480 ⁴

¹ = M340i xDrive and M340d xDrive: 4713mm ² = xDrive models: 1445mm. 330e and 330e xDrive: 1444mm. M340i xDrive and M340d xDrive: 1440mm. ³ = xDrive models: 12m. ⁴ = 330e and 330e xDrive: 375 litres. ⁵ = M340i xDrive and M340d xDrive: 802mm.
⁶ = M340i xDrive and M340d xDrive: 1060mm.

DIMENSIONS.

THE BMW 3 SERIES TOURING.

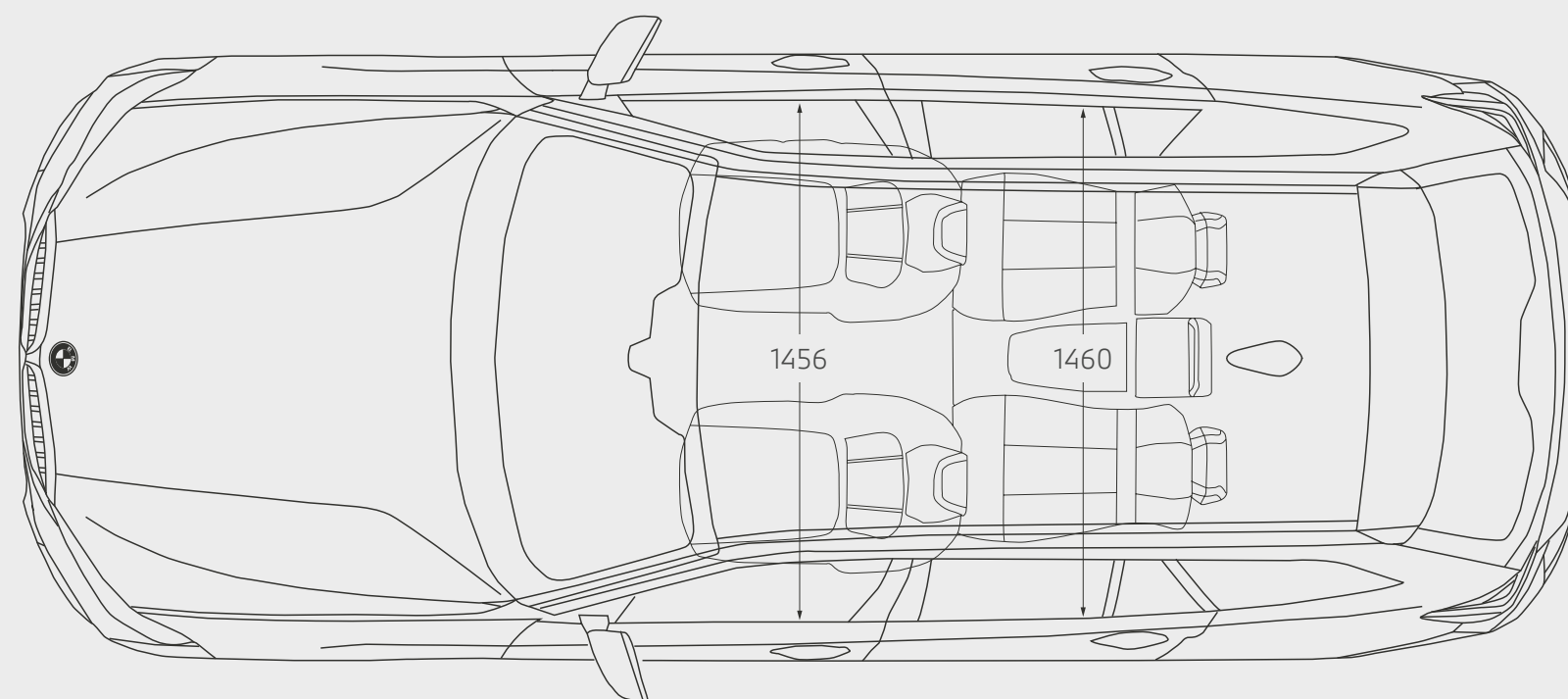
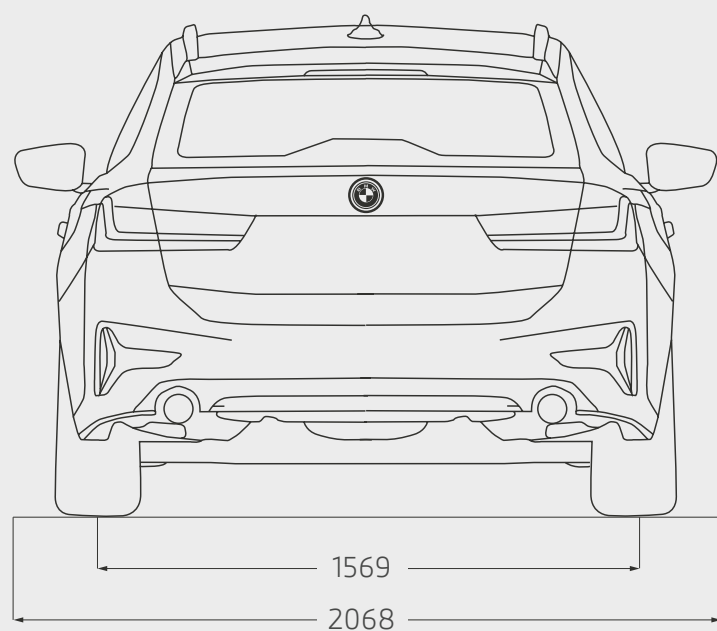
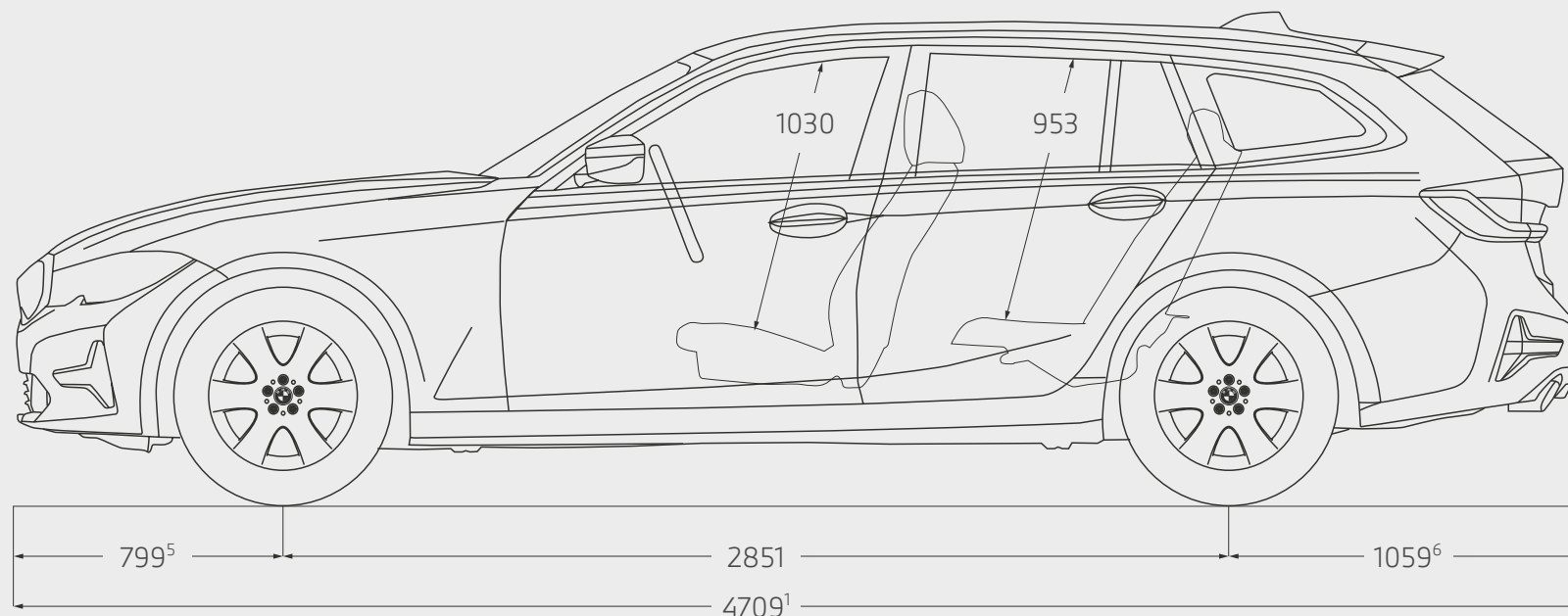
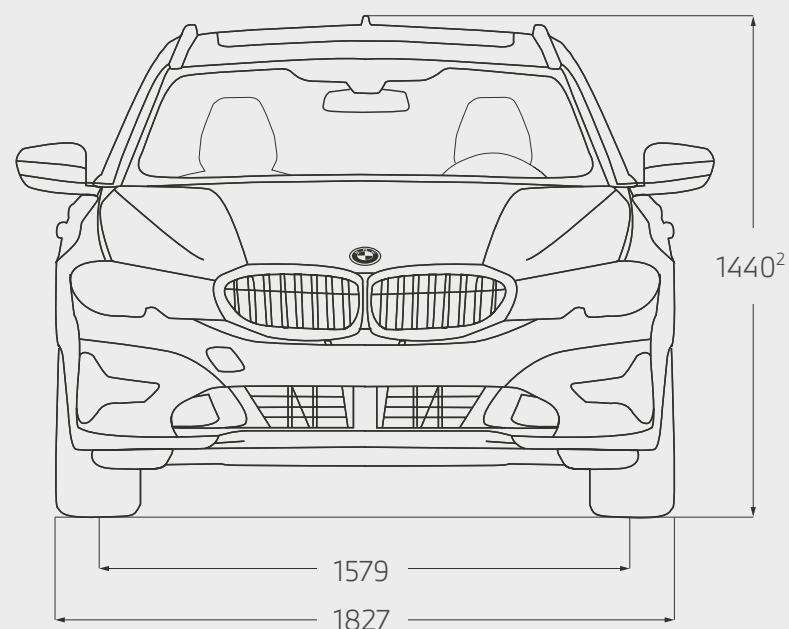

Length (mm)	4709 ¹	Height (mm)	1440 ²	Number of seats	5	Turning circle (m)	11.4 ³
Width (mm)	1827	Width including mirrors (mm) (Driver / Passenger)	2068 (1040 / 1028)	Wheelbase (mm)	2851	Luggage capacity (litre)	500-1510 ⁴

¹ = M340i xDrive and M340d xDrive: 4713mm ² = xDrive models: 1445mm. 330e and 330e xDrive: 1442mm. M340i xDrive and M340d xDrive: 1440mm. ³ = xDrive models: 12m. ⁴ = 330e and 330e xDrive: 410-1420 litres. ⁵ = M340i xDrive and M340d xDrive: 802mm.
⁶ = M340i xDrive and M340d xDrive: 1060mm.

BMW PAY MONTHLY SERVICING & TRACKSTAR.

SERVICING MADE SIMPLE.

Planning for the road ahead has never been easier. With the BMW Pay Monthly Service Plan¹ you can remove the uncertainty often associated with car servicing costs by spreading them monthly, much like you would your household bills. Our Pay Monthly service plan covers two services and any unused credit can be transferred to another BMW if you decide to switch unexpectedly. As part of the Pay Monthly plan you will also receive a number of added extras including:

- Fluid top ups
- An MOT
- A Wash & Vac each time you visit
- Seasonal health checks
- Sat Nav Map updates

Get the quality service and parts you expect from BMW with a fixed monthly payment. Give your BMW the care and attention it deserves from the experts that made it.

Price: £25 per month for 36 months

Please contact your preferred BMW Centre for further information.

BMW TRACKSTAR.

Locate and recover your vehicle if it is stolen with BMW Trackstar or BMW Trackstar Advance. Benefits include:

- 24/7 Trackstar Monitoring Centre
- Thatcham accredited
- Integrated motion sensor
- Pan-European protection

BMW Trackstar S7 price from: £399²

BMW Trackstar S5 price from £549²

BMW Trackstar S5 Advance price from: £649²



¹ = Participating BMW Centres only. Two services must be claimed within four years or 40,000 miles, whichever occurs soonest. ² = Price excludes subscription. Please consult your preferred BMW Centre for further details. Content correct at time of publishing. Prices subject to change.

BMW CONNECTED DRIVE SERVICES.

BMW ConnectedDrive keeps driver and vehicle connected with the outside world. Digital services, driver-focused technologies and driver assistance systems provide more comfort, more entertainment and more safety. Increase your driving pleasure – with BMW ConnectedDrive.

For further information on BMW ConnectedDrive and the General Terms and Conditions of Service for ConnectedDrive, please see: www.bmw.co.uk/connecteddrive-information

The BMW ConnectedDrive Hotline is available on: +44 (0) 800 561 0555 from Monday to Friday 8am – 7pm and Saturday to Sunday 9am – 5pm.

CONNECTED DRIVE SERVICES DURATION

BMW Music	3 month trial
BMW Apps	3 years
BMW Intelligent Personal Assistant	3 years
BMW Maps	3 years
BMW Online Services	3 years
Concierge Services	3 years
Connected Charging (330e / 330e xDrive only)	3 years
Connected Music	3 years
Connected Parking	3 years
In-Car Experiences	3 years
Intelligent Functionalities	3 years
Map Updates	3 years
Real Time Traffic Information	3 years
Remote Services	3 years
Remote Software Upgrade	3 years
BMW Emergency Call	Active without runtime limitations
BMW TeleServices	Active without runtime limitations
Last State Call	Active without runtime limitations
Smartphone Integration	Active without runtime limitations

GENERAL INFORMATION

BMW (UK) Ltd, Summit ONE, Summit Avenue, Farnborough, Hampshire, GU14 0FB (hereinafter referred to as "BMW") provides the customer with certain vehicle-related information and assistance functions (hereinafter called "Services") under the name of "BMW ConnectedDrive". BMW collects, stores or processes car-related data in compliance with applicable law and only to the extent necessary to provide the Services. BMW does not collect, store or process personal data in course of the Services – except where this is explicitly stated in the service description of the individual Services. In the case of Services that require personal data to be collected, stored and processed so that such Services can actually be provided, BMW informs customers of this in advance by providing this data protection notice. The Services are provided by means of a SIM card installed in the vehicle.

DEACTIVATION

You can have the BMW ConnectedDrive services deactivated through an authorised BMW centre, a BMW subsidiary or a BMW authorised workshop at any time. This also has the consequence that aspects of the emergency call in the vehicle as well as all remaining Services will no longer function.

You can additionally arrange for the remaining Services to be deactivated via "My BMW ConnectedDrive".

If the vehicle is equipped with the legally required EU Emergency Call (as from April 2018) a deactivation of the BMW ConnectedDrive basic services will not deactivate the vehicle's built-in SIM card. It has to remain active, so that the EU Emergency Call is functional all the time.

Services that are available and active without runtime limitations, cannot be guaranteed for permanent usage due to potential future technical developments (of the Service availability and/or Smartphone compatibility/operating systems).





READY TO TAKE THE NEXT STEP?

