

T H E



X3

Best viewed in  
landscape mode



THE BMW X3.

RETURN BY CLICKING [🏠](#)  
SELECT A TOPIC BELOW TO EXPLORE:



## FEATURED MODEL.

### BMW X3 M40i:

BMW M Performance TwinPower Turbo six-cylinder in-line petrol engine, 360hp (265kW), 21" BMW M light alloy Double-spoke style 718 M wheels, Cerium Grey with mixed tyres, Phytonic Blue metallic paint, Sport seats for driver and front passenger in Vernasca leather upholstery in Cognac with contrast stitching, Aluminium Rhombicle interior trim with Pearl Chrome finisher, instrument panel in Sensatec.

Content correct at time of publishing (as of January 2021). Prices and technical data subject to change. The models shown on these pages may feature optional equipment. Standard equipment may also vary depending on engine variant. For further details, please contact your local BMW Centre.



"EXTRA REFINEMENT, SPACE AND CLASS."

Autocar

[Read the full review](#)



"OVERALL THE X3 IS STILL A STRONG CONTENDER IN THE COMPACT PREMIUM SUV CLASS, THANKS TO ITS EFFICIENT YET POWERFUL ENGINES, SPACIOUS INTERIOR AND INVOLVING DRIVING EXPERIENCE."

Auto Express, April 2020

[Read the full review](#)



"THE X3 COMES WITH BUNDLES OF HANDY FEATURES TO MAKE IT EASY TO LIVE WITH – THERE'S EVEN A HANDY STRUT TO HOLD UP THE BOOT FLOOR WHILE YOU FIDDLE AROUND WITH YOUR LUGGAGE."

What Car?

[Read the full review](#)

M40i/d.



The BMW X3 M40i model is shown above in Phytonic Blue metallic paint.

■ Standard equipment □ Optional equipment

In addition / replacement to M Sport models

## EXTERIOR

- 20" M light alloy Double-spoke style 699 M wheels, Bicolour Orbit Grey
- BMW Icon Adaptive LED Headlights with High-beam Assistant
- Kidney grille, Cerium Grey with Black, High-gloss vertical slats
- Mirror caps, Air Breather and front air inlets in Cerium Grey
- Exhaust tailpipe –dual, quadrilateral, with Black Chrome finisher

## INTERIOR

- Seat adjustment – front, electric with driver memory
- Sensatec dashboard
- Sun protection glass
- Headlining, Anthracite

## SAFETY & TECHNOLOGY

- M Sport braking system, High-gloss Red
- M Sport differential
- M Sport suspension
- Sport automatic transmission
- Variable Sport steering



M SPORT.



The BMW X3 M Sport model is shown above in Alpine White non-metallic paint with optional 20" M Double-spoke style 699 M wheels, Bicolour Orbit Grey.

■ Standard equipment □ Optional equipment



# M SPORT.

In addition / replacement to SE

## EXTERIOR

- 19" M light alloy Double-spoke style 698 M wheels, Ferric Grey
- LED foglights, front
- Exterior trim, High-gloss Shadowline
- Roof rails, High-gloss Shadowline
- Kidney grille, Chrome with Black, High-gloss vertical slats
- M aerodynamic bodystyling
- Side exterior M designation badges

## INTERIOR

- Sport seats, front
- Interior trim, Aluminium Rhombicle with Pearl Chrome finisher
- M Sport multi-function leather steering wheel
- Headlining, Anthracite
- Remote control, including integrated key, with inset in Blue

## SAFETY & TECHNOLOGY

- Larger fuel tank (xDrive20d / xDrive30d only)
- M Sport braking system, High-gloss Blue (xDrive30d only)
- M Sport suspension (excluding xDrive30e)
- Performance Control

## AUDIO & COMMUNICATION

- BMW Live Cockpit Professional, comprising:
  - 10.25" Control Display with Touch Functionality
  - 12.3" Digital Instrument Display
  - BMW Operating System 7.0
  - iDrive Controller with Touch Function
- Connected Package Professional



The BMW X3 M Sport model is shown above in Alpine White non-metallic paint with optional 20" M Double-spoke style 699 M wheels, Bicolour Orbit Grey.

■ Standard equipment □ Optional equipment

xLINE.



The BMW X3 xLine model is shown above in Sophisto Grey metallic paint with optional 20" Y-spoke style 695 wheels, Bicolour Orbit Grey.

■ Standard equipment □ Optional equipment

## xLINE.

In addition / replacement to SE

### EXTERIOR

- 19" light alloy Y-spoke style 694 wheels, Ferric Grey
- LED foglights, front
- Exterior trim, Satin Aluminium
- Kidney grille, Chrome with Matt Aluminium vertical slats
- Side sills in Matt Glacier Silver Metallic
- xLine exterior styling with underbody protection

### INTERIOR

- Sports seats, front
- Interior trim, High-gloss Black with Pearl Chrome finisher
- Door sill finishers with BMW xLine designation, front

### SAFETY & TECHNOLOGY

- Larger fuel tank (xDrive20d / xDrive30d only)



The BMW X3 xLine model is shown above in Sophisto Grey metallic paint with optional 20" Y-spoke style 695 wheels, Bicolour Orbit Grey.

■ Standard equipment □ Optional equipment

SE.



The BMW X3 SE model is shown above in Glacier Silver metallic paint.

■ Standard equipment □ Optional equipment

SE.

#### EXTERIOR

- 18" light alloy V-spoke style 618 wheels (xDrive20i / xDrive20d only)
- 18" light alloy Double-spoke style 688 wheels (xDrive30e / xDrive30d only)
- Adaptive LED headlights
- Dynamic brake lights
- Roof rails, Satin Aluminium
- Tailgate operation, automatic
- Exterior mirrors –electrically folding with anti-dazzle
- Exterior trim, Matt Black
- Kidney grille, Chrome with Black vertical slats

#### INTERIOR

- Seat heating, front
- Sport multi-function leather steering wheel, three-spoke
- Air conditioning, automatic with three-zone control
- Acoustic glazing
- Ambient lighting
- Interior rear-view mirror with automatic anti-dazzle function
- Interior trim, High-gloss Black with Pearl Chrome finisher
- Through-loading system (with 40:20:40 split-folding rear seats)

#### SAFETY & TECHNOLOGY

- 48V Mild Hybrid Technology (xDrive20d only)
- Active Guard
- Cruise control with braking function
- Drive Performance Control (ECO PRO, Comfort and Sport modes)
- Park Distance Control, front and rear
- Reversing Assist camera
- xDrive four-wheel-drive with fully variable torque split
- Variable Sport Steering
- Eight-speed automatic transmission with electronic gear selector and Steptronic (xDrive30e / xDrive30d only)
- Eight-speed automatic transmission, with gearshift paddles (xDrive20i / xDrive20d only)
- Servotronic
- BMW mobility kit
- Tyre Pressure Monitoring

#### AUDIO & COMMUNICATION

- Bluetooth hands-free facility with USB audio interface (including Bluetooth audio streaming)
- BMW Live Cockpit Plus, comprising:
  - 5.7" Digital Instrument Display
  - 8.8" Control Display with Touch Functionality
  - BMW iDrive 6 System (iD6)
  - iDrive controller with Touch Function
- Connected Package Plus
- DAB tuner



## xDRIVE30e.

Featuring innovative BMW eDrive and EfficientDynamics technologies, the BMW X3 xDrive30e provides impressive levels of performance and efficiency. Offering the best of both worlds, this Plug-in Hybrid Electric Vehicle (PHEV) combines a powerful petrol engine with an electric motor that is powered by a lithium-ion battery, overall providing an exceptional pure electric driving range with the flexibility of a combustion engine. The BMW X3 xDrive30e is everything you would expect from a BMW and more, with electrifying driving pleasure, this represents the future of the Ultimate Driving Machine.

The BMW X3 xDrive30e – plug into the future today.



Pure electric range of 28.6-31.7 miles (46.0-51.0km)\*

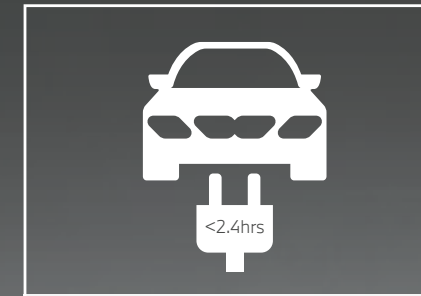

Charging time 0-80% in <2.4 hours (based on a current of 16A)^

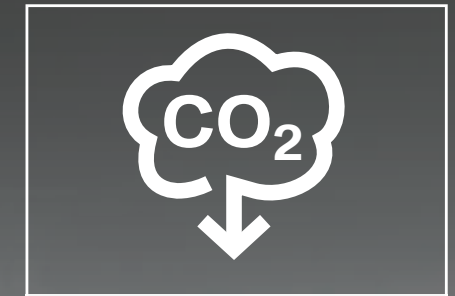

Low CO<sub>2</sub> emissions of 53-44g/km\*



The BMW X3 xDrive30e xLine model is shown above in Mineral White metallic paint. ^ = Dependent on the local electricity infrastructure. Charging time corresponds to a charge of 80% of maximum capacity and based on a single-phase supply current of max 32A. \* = For Plug-in Hybrid Electric Vehicles these figures were obtained using a combination of battery power and fuel. Plug-in Hybrid Electric Vehicles require mains electricity for charging. Figures shown are for comparability purposes. Only compare fuel consumption, CO<sub>2</sub> and electric range figures with other cars tested to the same technical procedures. These figures may not reflect real life driving results, which will depend upon a number of factors including the starting charge of the battery, accessories fitted (post-registration), variations in weather, driving styles and vehicle load.

■ Standard equipment □ Optional equipment

# EXTERIOR COLOURS.

ALL MODELS.



Non-metallic Alpine White



Metallic Glacier Silver

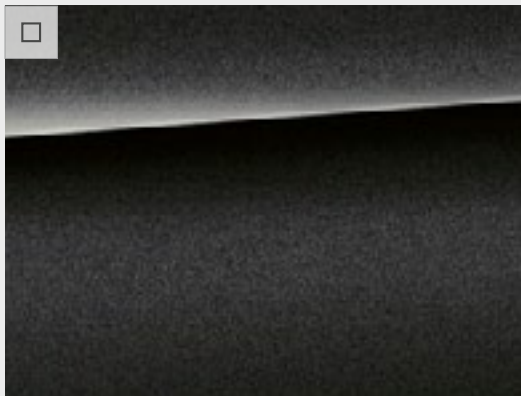

Metallic Sophisto Grey

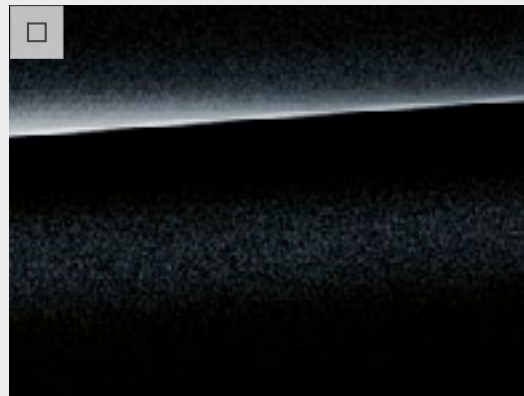

Metallic Black Sapphire



Metallic Phytonic Blue

EXCLUSIVELY FOR SE & xLINE MODELS.



Metallic Mineral White

EXCLUSIVELY FOR M SPORT, M40i & M40d MODELS.

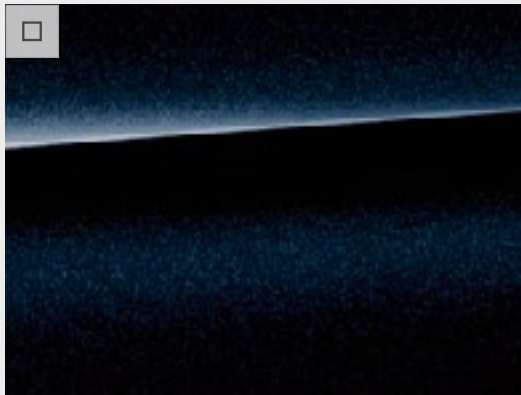

Metallic Carbon Black

**Colour samples** These colour samples are intended as an initial guide to the colours and materials available for your BMW. Please discuss your preferred colour choices with your BMW Centre. There you can also see original samples and be assisted with any requests.

■ Standard equipment   □ Optional equipment

# UPHOLSTERY & INTERIOR TRIMS.

## LEATHER.

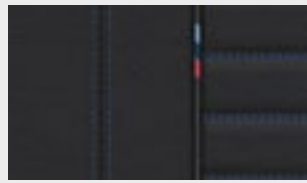

Vernasca leather in Black with Blue contrast stitching and interior colour in Black

- Available with
- M Sport
  - M40i
  - M40d
- Only with Instrument panel in Sensatec.

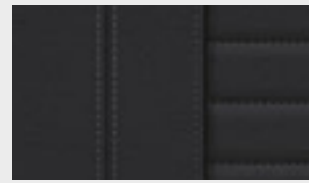

Vernasca leather in Black with Grey contrast stitching and interior colour in Black

- Available with
- SE
  - xLine
  - M Sport
  - M40i
  - M40d



Vernasca leather in Cognac with contrast stitching and interior colour in Black

- Available with
- xLine
  - M Sport
  - M40i
  - M40d

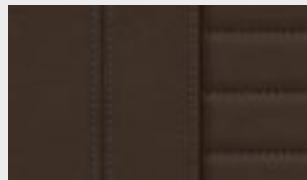

Vernasca leather in Mocha with contrast stitching and interior colour in Black

- Available with
- xLine
  - M Sport
  - M40i
  - M40d

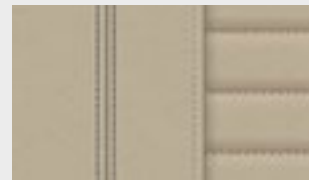

Vernasca leather in Oyster with contrast stitching including extended contents and interior colour in Black

- Available with
- xLine
  - M Sport
  - M40i
  - M40d

## INTERIOR TRIMS.



Aluminium Rhombicle with Pearl Chrome

- Available with
- M Sport
  - M40i
  - M40d

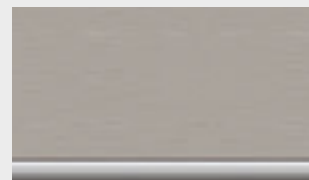

Aluminium fine cutting with Pearl Chrome finisher

- Available with
- SE
  - xLine
  - M Sport
  - M40i
  - M40d

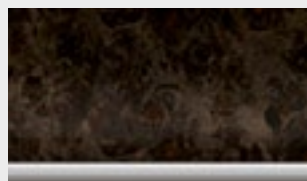

Poplar grain Grey fine-wood with Pearl Chrome finisher

- Available with
- SE
  - xLine
  - M Sport
  - M40i
  - M40d



High-gloss Black with Pearl Chrome finisher

- Available with
- SE
  - xLine



Dark Oak Wood, High-gloss with Pearl Chrome finisher

- Available with
- SE
  - xLine
  - M Sport
  - M40i
  - M40d

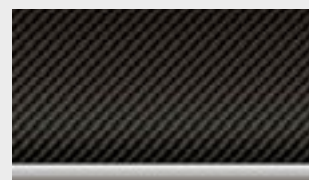

Carbon Fibre

- Available with
- M40i
  - M40d

## BMW INDIVIDUAL.



Piano Black

- Available with
- M Sport
  - M40i
  - M40d

## HEADLINING.

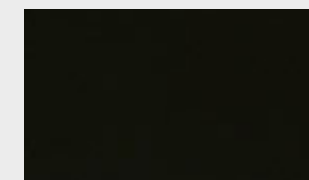

Anthracite

- Available with
- M Sport
  - M40i
  - M40d



# PACKAGES.

Optional packages offer an attractive combination of the most popular options at a reduced (combined) cost and will enhance any journey in the BMW X3.

## COMFORT PACKAGE.

- Steering wheel heating
- Comfort Access with smart-opener
- Seat backrest adjustment for rear seats
- Extended storage



## COMFORT PLUS PACKAGE.

- All contents from Comfort Package
- Lumbar support, front
- Seat adjustment – front, electric with driver memory



Exclusively for SE, xLine and M Sport models.

## VISIBILITY PACKAGE.

- BMW Icon Adaptive LED Headlights
- High-beam Assistant



Standard for M40i and M40d models.

## M SPORT PLUS PACKAGE.

- 20" M light alloy Double-spoke style 699 M wheels, Bicolour Orbit Grey
- Active Protection
- Adaptive suspension
- Extended High-gloss Shadowline
- M seat belts
- M Sport braking system, High-gloss Blue
- Sun protection glass
- Variable sport steering

Alternative content:

- 21" M BMW Individual light alloy V-spoke style 726 wheels with run-flat tyres
- M Sport braking system, High-gloss Red

Exclusively for M Sport models.



## M SPORT PLUS PACKAGE.

- 21" M light alloy Double-spoke style 718 M wheels, Cerium Grey matt, with run-flat tyres
- Active Protection
- Adaptive M suspension
- Extended High-gloss Shadowline
- Lumbar support, front
- M seat belts
- M seats

Exclusively for M40i and M40d models.



## TECHNOLOGY PACKAGE.

- BMW Gesture Control
- Enhanced Bluetooth with wireless charging
- Head-up Display
- Loudspeaker system – harman/kardon
- WiFi hotspot preparation

Exclusively for M Sport, M40i and M40d models.



# OPTIONAL EQUIPMENT HIGHLIGHTS.

## TOWBAR, FULLY ELECTRIC.

The towbar with electrically adjustable tow ball and trailer stability control is approved for heavy loads of up to 2,400kg.



## PARKING ASSISTANT PLUS.

Parking Assistant Plus consists of Parking Assistant plus Surround View (Top View, Panorama View and 3D View) and Remote 3D View.

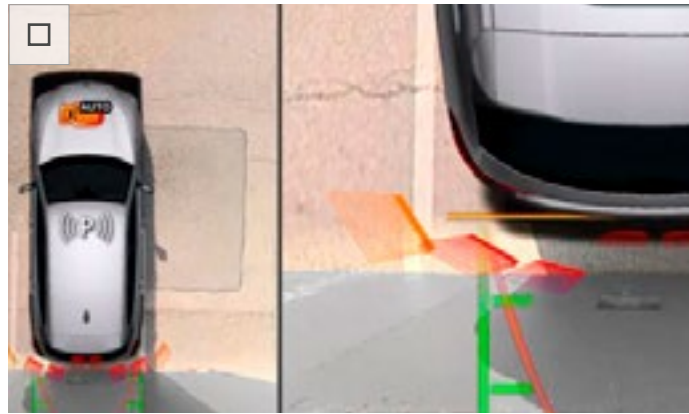

## EXTENDED STORAGE.

Extended storage offers increased functionality and practicality by offering more organisational and storage space. This feature comprises:

- Sunglasses storage compartment
- Lockable glovebox
- 12V power socket in rear centre console
- Storage nets behind front seats
- Lashing rails for luggage compartment
- USB adapter
- Multi-functional hooks in luggage compartment
- Luggage compartment loading sill in stainless steel (xLine and M Sport models only)



Included in the Comfort Package and Comfort Plus Package.

## BMW GESTURE CONTROL.

With BMW Gesture Control, certain functions can be operated by means of defined hand movements. For certain operations the system will, for example, recognise gestures such as 'swiping' or 'pointing' for accepting or rejecting an incoming call, or circular motions of the index finger to adjust volume.

Exclusively available as part of Technology Package for M Sport, M40i and M40d models.



## LOUDSPEAKER SYSTEM – HARMAN/KARDON.

The outstanding harman/kardon loudspeaker system produces a sound that expresses tones, instruments and musical subtleties down to the most nuanced perceptible detail. The system's main features are the 600W amplifier, nine channels and 16 speakers that create a full, consistent sound at every seat.

Exclusively for M Sport, M40i and M40d models.



## ENHANCED BLUETOOTH WITH WIRELESS CHARGING.

Enhanced Bluetooth with wireless charging offers a comprehensive telephony package with Bluetooth connectivity and the technical capacity for a WiFi hotspot. Two mobile telephones and an audio player can be connected simultaneously via Bluetooth at any given time. A smartphone holder within the centre console can be used for inductive charging for compatible smartphones.

Also included as part of Technology Package for M Sport, M40i and M40d models.



## DRIVING ASSISTANT PLUS.

Driving Assistant Plus offers greater comfort and security during monotonous or complex driving situations. These can include traffic jams, stop-and-go traffic or long journeys through the city, on country roads or motorways, along with navigating junctions and lane changes.

The system scopes contained in the Driving Assistant Plus only provide assistance within defined system limits. It remains the responsibility of the respective driver to react to the actual traffic situation. Only available with the Galvanic embellisher for controls.



## HEAD-UP DISPLAY.

The full-colour Head-up Display projects all information relevant to the journey directly into the driver's field of vision. Display of full content is dependent on optional equipment ordered.

Exclusively available for M Sport, M40i and M40d models as part of Technology Package.



# BMW CONNECTED DRIVE.

BMW ConnectedDrive enables you to remain connected to the outside world from the comfort of your BMW.



## ■ BMW LIVE COCKPIT PLUS.

Exclusively for SE and xLine models:

- **BMW Apps** makes it possible to operate apps such as BMW Connected.
- **BMW Emergency Call** automatically creates a direct link to the local emergency services.
- **BMW Online Services** provides a seamless integration of personalised BMW Connected mobility-related services.
- **BMW Teleservices** supports the processing of servicing appointments and sends vehicle-specific service data to BMW.
- **Intelligent Voice Control** understands natural speech as well as linguistic varieties and dialects thanks to off-board voice processing.
- **Last State Call** transfers vehicle-based data to the BMW Connected App, allowing you to view current mileage, fuel status and other features from your phone.
- **Map updates** automatically updates the maps in your BMW by downloading them over the air.



## ■ CONNECTED PACKAGE PLUS.

Exclusively for SE and xLine models:

- **Apple CarPlay® preparation** enables wireless usage of your iPhone in your vehicle via Apple CarPlay.
- **Concierge Services** connects the driver to a BMW Call Centre agent around-the-clock.
- **Remote Services** allows you to remain connected to your vehicle from your phone.
- **Real Time Traffic Information** supplies details about the location and duration of traffic delays.



## ■ BMW LIVE COCKPIT PROFESSIONAL.

Additionally, M Sport, M40i and M40d models receive the following as standard:

- **Fully digital 12.3" instrument display** as well as a high-resolution **10.25" Control Display**.
- **BMW Operating System 7.0** with variable, configurable widgets that display information in real time.



## ■ CONNECTED PACKAGE PROFESSIONAL.

In addition to Connected Package Plus, M Sport, M40i and M40d models receive the following as standard:

- **BMW Maps** makes route planning easier, anticipates road conditions and provides an estimated time of arrival.
- **Connected Charging** enables the search and display of charging points, as well as the display of range and charging features for xDrive30e models.
- **Connected Music** offers unlimited streaming of millions of songs in the vehicle from Spotify.
- **Connected Parking** offers multi-story and on-street parking information in selected cities in the UK and Europe.
- With **Smartphone Integration**, your vehicle supports Apple CarPlay® and Android Auto®. This way you can access your usual apps in the vehicle.

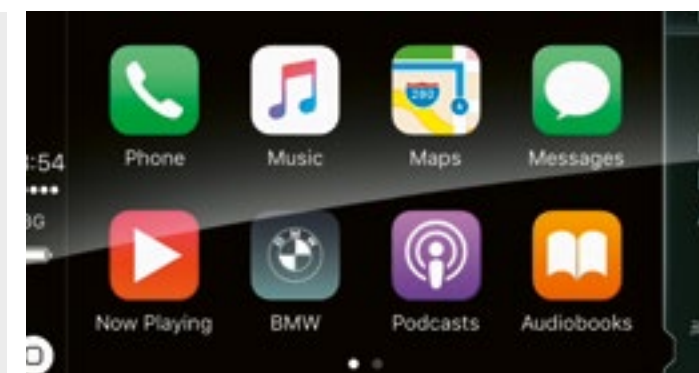

## ■ CONNECTED TEASER.

Available with Connected Package Professional and offers a three month trial of the following service:

- **BMW Music** brings your favourite soundtracks to your BMW.



## MY BMW APP.

The My BMW App is the direct connection inside and outside your BMW. Plan your next trip, check the status of your vehicle or use one of the remote service functions – all conveniently from your smartphone.

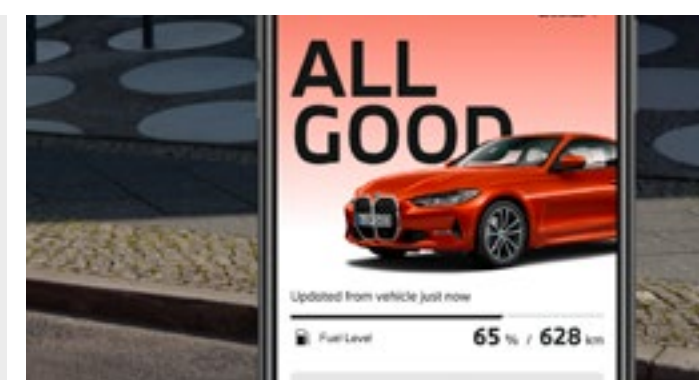

# WHEELS & TYRES.

21" BMW INDIVIDUAL LIGHT ALLOY V-SPOKE STYLE 726 I WHEELS, BICOLOUR.

21" BMW Individual light alloy V-spoke style 726 I wheels, Bicolour, Orbit Grey, front 8.5 J x 21 with 245/40 R21, rear 9.5 J x 21 with 275/35 R21 run-flat tyres.

Exclusively for xLine and M Sport models.



21" M LIGHT ALLOY DOUBLE-SPOKE STYLE 718 M WHEELS, MATT CERIUM GREY.

21" M light alloy Double-spoke style 718 M wheels, Matt Cerium Grey, front 8.5J x 21 with 245/40 R21, rear 9.5J x 21 with 275/35 R21 run-flat tyres.

Optional for M40d and M40i models, as part of the M Sport Plus Package only.

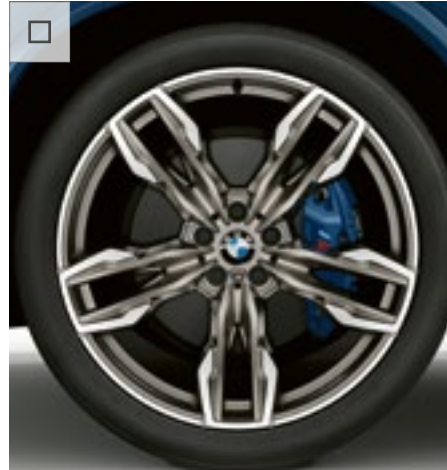

20" M LIGHT ALLOY DOUBLE-SPOKE STYLE 699 M WHEELS, ORBIT GREY.

20" M light alloy Double-spoke style 699 M wheels, Orbit Grey with mixed tyres, front 8J x 20 with 245/45 R20, rear 9.5J x 20 with 275/40 R20 tyres.

Standard for M40i and M40d models. Optionally available for M Sport models as part of M Sport Plus Package.



19" LIGHT ALLOY Y-SPOKE STYLE 694 WHEELS, FERRIC GREY.

19" light alloy Y-spoke style 694 wheels, Ferric Grey, front and rear 7.5J x 19 with 245/50 R19 tyres.

Standard for xLine.



20" LIGHT ALLOY Y-SPOKE STYLE 695 WHEELS, BICOLOUR ORBIT GREY.

20" light alloy Y-spoke style 695 wheels, Bicolour Orbit Grey, front 8 J x 20 with 245/45, rear 9.5 J x 20 with 275/40 tyres.

Optional for xLine.



19" M LIGHT ALLOY DOUBLE-SPOKE STYLE 698 M WHEELS, FERRIC GREY.

19" M light alloy Double-spoke style 698 M wheels, Ferric Grey, 7.5 J x 19 with 245/50 R19 tyres.

Standard for M Sport models.



18" LIGHT ALLOY V-SPOKE STYLE 618 WHEELS.

18" light alloy V-spoke style 618 wheels, wheel size 7J x 18, with 225/60 R18 tyres.

Standard for xDrive20i and xDrive20d SE models.



19" LIGHT ALLOY V-SPOKE STYLE 692 WHEELS, BICOLOUR FERRIC GREY.

19" light alloy V-spoke style 692 wheels, Bicolour Ferric Grey, front and rear 7.5J x 19 with 245/50 R19 tyres.

Optional for SE models.

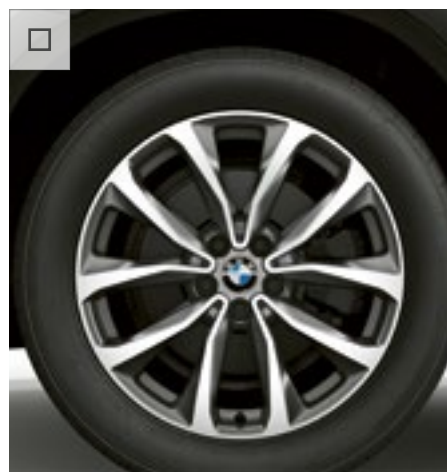

18" LIGHT ALLOY DOUBLE-SPOKE STYLE 688 WHEELS.

18" light alloy Double-spoke style 688 wheels, wheel size 7J x 18 with 225/60 R18 tyres.

Standard for xDrive30e and xDrive30d SE models. Optionally available for xDrive20i and xDrive20d SE models.

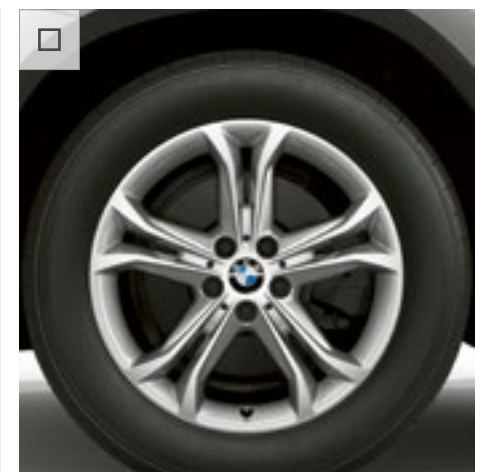

# GENUINE BMW ACCESSORIES.



## ROOF BOX.

This contemporary BMW Roof box in Black with titanium silver side trims has a 520-litre capacity and fits all BMW Roof rack systems. It can be opened from both sides and features triple central locking on each side which makes it easy to load and provides anti-theft locking. BMW Roof boxes in other sizes are also available.

## 20" LIGHT ALLOY Y-SPOKE STYLE 695 WHEELS, MATT BLACK.

The premium-quality 20" light alloy Y-spoke style 695 wheels are in Matt Black. Complete summer wheel set with mixed, run-flat tyres. Also available as a complete winter wheel set.



## ROOF BARS.

BMW Roof Bars allow you to carry a number of items on the roof of your car, including roof boxes and bike carriers.



## BMW REAR BIKE CARRIER.

The Rear Bike Carrier is lightweight yet sturdy and can carry up to 60kg (2 x 30kg). Exceptionally easy to use, it carries two bicycles or e-bikes. Its tilt function also allows easy access to the luggage compartment at all times.



## LUGGAGE COMPARTMENT MAT.

Fitted luggage compartment mat: anti-slip, water-resistant, durable mat for protecting the luggage compartment from dirt and moisture.



## ADVANCED CAR EYE 2.0.

The highly sensitive full-HD Advanced Car Eye 2.0 records automatically in order to capture events as seen from the vehicle, even when it is parked.



## ALL-WEATHER FLOOR MATS.

All-weather floor mats: precisely fitting protection against moisture and dirt in the front footwells. In Black, the mats are a perfect match with the interior.



# PRICING INFORMATION.



xDrive20i SE	xDrive20i xLine	xDrive20i M Sport	xDrive30e SE	xDrive30e xLine	xDrive30e M Sport	M40i	xDrive20d SE	xDrive20d xLine	xDrive20d M Sport	xDrive30d SE	xDrive30d xLine	xDrive30d M Sport	M40d
--------------	-----------------	-------------------	--------------	-----------------	-------------------	------	--------------	-----------------	-------------------	--------------	-----------------	-------------------	------

Basic price (excluding VAT)	£33,616.67	£34,366.67	£35,825.00	£40,287.50	£41,037.50	£42,495.83	£45,225.00	£34,683.33	£35,433.33	£36,891.67	£39,504.17	£40,254.17	£41,712.50	£45,225.00
VAT 20%	£6,723.33	£6,873.33	£7,165.00	£8,057.50	£8,207.50	£8,499.17	£9,045.00	£6,936.67	£7,086.67	£7,378.33	£7,900.83	£8,050.83	£8,342.50	£9,045.00
RRP (including VAT)	£40,340	£41,240	£42,990	£48,345	£49,245	£50,995	£54,270	£41,620	£42,520	£44,270	£47,405	£48,305	£50,055	£54,270
On the road price from	£42,115	£43,015	£44,765	£49,250	£50,150	£51,900	£56,480	£43,055	£43,955	£45,705	£48,840	£49,740	£51,490	£56,035
P11d value – Automatic	£41,190	£42,090	£43,840	£49,195	£50,095	£51,845	£55,120	£42,470	£43,370	£45,120	£48,255	£49,155	£50,905	£55,120
BIK tax rate (2020 / 2021)	37%	37%	37%	10%	13%-10%	13%-10%	37%	34%-33%	36%-33%	36%-34%	36%-35%	37%-35%	37%-35%	37%
Insurance group	28	28	29	38	38	39	40	33	33	33	41	41	41	43
RDE2 Certified (Y / N)	Y	Y	Y	Y	Y	Y	Y	Y	Y	Y	Y	Y	Y	Y

## PRICES AND SPECIFICATIONS

BMW (UK) Limited reserves the right to alter prices and specifications without notice. BMW (UK) Limited has made every effort to ensure the accuracy of information but does not accept liability for any errors or omissions.

## VED RATES

Annual VED (second year onwards), for cars costing over £40,000, is payable for five years. VED rates for brand new cars are determined by their CO<sub>2</sub> emissions figure. First year VED applies to the first year of ownership. Annual VED rates apply thereafter. The BMW X3 models fall into one of the categories listed below:

CO <sub>2</sub> emissions (g/km)	01-50	51-75	76-90	91-100	101-110	111-130	131-150	151-170	171-190	191-225	226-255	Over 255
First year VED (petrol and RDE2 diesel)	£10	£25	£110	£135	£155	£175	£215	£540	£870	£1,305	£1,850	£2,175
First year VED (alternative fuel vehicles)	£0	£15	£100	£125	£145	£165	£205	£530	£860	£1,295	£1,840	£2,165
Annual VED – second year onwards (standard rate for petrol and diesel)	£150	£150	£150	£150	£150	£150	£150	£150	£150	£150	£150	£150
Annual VED – second year onwards (standard rate for alternative fuel vehicles)	£140	£140	£140	£140	£140	£140	£140	£140	£140	£140	£140	£140
Annual VED – second year onwards (petrol and diesel cars over £40,000)	£475	£475	£475	£475	£475	£475	£475	£475	£475	£475	£475	£475
Annual VED – second year onwards (alternative fuel vehicles over £40,000)	£465	£465	£465	£465	£465	£465	£465	£465	£465	£465	£465	£465

## ON THE ROAD PRICE

The recommended on the road price includes:

Delivery and BMW Emergency Service	£825
Number plates	£25
Vehicle first registration fee	£55
First year Vehicle Excise Duty	See left

For Plug-in Hybrid Electric Vehicles these figures were obtained using a combination of battery power and fuel. Plug-in Hybrid Electric Vehicles require mains electricity for charging. Figures shown are for comparability purposes. Only compare fuel consumption, CO<sub>2</sub> and electric range figures with other cars tested to the same technical procedures. These figures may not reflect real life driving results, which will depend upon a number of factors including the starting charge of the battery, accessories fitted (post-registration), variations in weather, driving styles and vehicle load. The CO<sub>2</sub> figures have been determined according to the WLTP test. WLTP has been used as the applicable CO<sub>2</sub> figure from 1 April 2020 for first year vehicle tax (VED) and from 6 April 2020 for company car tax (BIK). The CO<sub>2</sub> figures were previously based on the NEDC equivalent. Insurance group figures refer to 50 Group Rating System.

# TECHNICAL INFORMATION.



xDrive20i SE	xDrive20i xLine	xDrive20i M Sport	xDrive30e SE	xDrive30e xLine	xDrive30e M Sport	M40i
--------------	-----------------	-------------------	--------------	-----------------	-------------------	------

xDrive20d SE	xDrive20d xLine	xDrive20d M Sport	xDrive30d SE	xDrive30d xLine	xDrive30d M Sport	M40d
--------------	-----------------	-------------------	--------------	-----------------	-------------------	------

Power output (hp)	184	184	184	292 <sup>^</sup>	292 <sup>^</sup>	292 <sup>^</sup>	360	190	190	190	286	286	286	340
0-62mph / 0-100km/h (secs)	8.3	8.3	8.3	6.1	6.1	6.1	4.8	7.9	7.9	7.9	5.7	5.7	5.7	4.9
Fuel consumption – combined (mpg)*	35.3-36.7	34.4-36.7	34.0-36.2	134.5-148.7**	122.8-148.7**	122.8-141.2**	30.1-31.4	46.3-47.9	44.8-47.9	44.1-47.9	44.1-45.6	42.8-45.6	42.2-45.6	40.4-43.5
Fuel consumption – combined (l/100km)*	8.0-7.7	8.2-7.7	8.3-7.8	2.1-1.9**	2.3-1.9**	2.3-2.0**	9.4-9.0	6.1-5.9	6.3-5.9	6.4-5.9	6.4-6.2	6.6-6.2	6.7-6.2	7.0-6.5
CO <sub>2</sub> emissions – combined (g/km)*	181-176	187-176	189-177	47-44**	52-44**	53-45**	215-204	159-154	165-154	167-155	167-161	173-161	175-163	184-171
Electric energy consumption – weighted combined (miles/kWh)**	-	-	-	3.3	3.2-3.3	3.2-3.3	-	-	-	-	-	-	-	-
Electric energy consumption – weighted combined (km/kWh)**	-	-	-	19.0-18.6	19.5-18.6	19.7-18.8	-	-	-	-	-	-	-	-
Equivalent all-electric range (miles)*	-	-	-	30.4-31.7	28.6-31.7	28.6-31.1	-	-	-	-	-	-	-	-
Equivalent all-electric range (km)*	-	-	-	49.0-51.0	46.0-51.0	46.0-50.0	-	-	-	-	-	-	-	-
Mild Hybrid Technology <sup>†</sup> (Y / N)	N	N	N	N	N	N	N	Y	Y	Y	Y	Y	Y	Y

CO<sub>2</sub> value will vary dependent on vehicle specification. Build your BMW and view the CO<sub>2</sub> figure for your chosen model [here](#). \* = For Plug-in Hybrid Electric Vehicles these figures were obtained using a combination of battery power and fuel. Plug-in Hybrid Electric Vehicles require mains electricity for charging. Figures shown are for comparability purposes. Only compare fuel consumption, CO<sub>2</sub> and electric range figures with other cars tested to the same technical procedures. These figures may not reflect real life driving results, which will depend upon a number of factors including the starting charge of the battery, accessories fitted (post-registration), variations in weather, driving styles and vehicle load. The CO<sub>2</sub> figures have been determined according to the WLTP test. WLTP has been used as the applicable CO<sub>2</sub> figure from 1 April 2020 for first year vehicle tax (VED) and from 6 April 2020 for company car tax (BIK). The CO<sub>2</sub> figures were previously based on the NEDC equivalent. \*\* = Figures are weighted combined. ^ = Combined power from Petrol and Electric engines. † = 48V Mild Hybrid Technology provides many benefits including improved recovery of kinetic energy during braking and support of the combustion engine when accelerating. This helps to reduce CO<sub>2</sub> emissions whilst improving fuel consumption and performance.

# OPTIONAL EQUIPMENT PRICING.

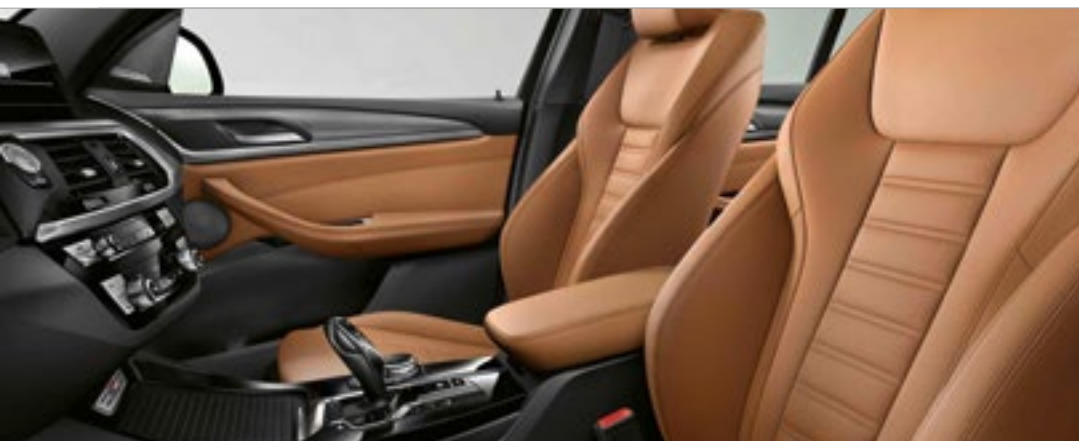

	xDrive20i SE	xDrive20i xLine	xDrive20i M Sport	xDrive30e SE	xDrive30e xLine	xDrive30e M Sport	M40i	xDrive20d SE	xDrive20d xLine	xDrive20d M Sport	xDrive30d SE	xDrive30d xLine	xDrive30d M Sport	M40d	Price
--	--------------	-----------------	-------------------	--------------	-----------------	-------------------	------	--------------	-----------------	-------------------	--------------	-----------------	-------------------	------	-------

## PAINTWORK

Non-metallic Available in Alpine White	■	■	■	■	■	■	■	■	■	■	■	■	■	■	Std
Metallic Available in Black Sapphire, Carbon Black <sup>1</sup> , Glacier Silver, Mineral White <sup>2</sup> , Phytonic Blue or Sophisto Grey	□	□	□	□	□	□	-	□	□	□	-	-	-	-	€670
	-	-	-	-	-	-	□	-	-	-	□	□	□	□	€0

## UPHOLSTERY

Vernasca leather – SE models Available in Black with contrast stitching	■	-	-	■	-	-	-	■	-	-	■	-	-	-	Std
– xLine models Available in Black with contrast stitching, Cognac with contrast stitching, Oyster with contrast stitching and extended content or Mocha with contrast stitching	-	■	-	-	■	-	-	-	■	-	-	■	-	-	Std
– M Sport and M40i / M40d models Available in Black with contrast stitching, Cognac with contrast stitching, Oyster with contrast stitching and extended content or Mocha with contrast stitching	-	-	■	-	-	■	■	-	-	■	-	-	■	■	Std
Available in Black with Blue contrast stitching Only with Instrument panel in Sensatec	-	-	□	-	-	□	□	-	-	□	-	-	□	□	€0

## BMW EFFICIENT DYNAMICS

Auto Start-Stop	■	■	■	■	■	■	■	■	■	■	■	■	■	■	Std
Brake Energy Regeneration	■	■	■	■	■	■	■	■	■	■	■	■	■	■	Std
Drive Performance Control	■	■	■	■	■	■	■	■	■	■	■	■	■	■	Std
ECO PRO mode	■	■	■	■	■	■	■	■	■	■	■	■	■	■	Std
Electric Power Steering (EPS)	■	■	■	■	■	■	■	■	■	■	■	■	■	■	Std
Reduced Rolling Resistance Tyres	■	■	■	■	■	■	■	■	■	■	■	■	■	■	Std
Lightweight Engineering	■	■	■	■	■	■	■	■	■	■	■	■	■	■	Std

Individual BMW EfficientDynamics features may be excluded, depending on the optional equipment chosen. Your BMW Centre will be pleased to provide you with more information.





xDrive20i SE	xDrive20i xLine	xDrive20i M Sport	xDrive30e SE	xDrive30e xLine	xDrive30e M Sport	M40i	xDrive20d SE	xDrive20d xLine	xDrive20d M Sport	xDrive30d SE	xDrive30d xLine	xDrive30d M Sport	M40d	Price
--------------	-----------------	-------------------	--------------	-----------------	-------------------	------	--------------	-----------------	-------------------	--------------	-----------------	-------------------	------	-------

PACKAGES

<b>COMFORT PACKAGE</b> Comprises: – Comfort Access with smart-opener – Extended Storage – Seat backrest adjustment, rear – Steering wheel heating	<input type="checkbox"/>	<input type="checkbox"/>	<input type="checkbox"/>	<input type="checkbox"/>	<input type="checkbox"/>	<input type="checkbox"/>	<input type="checkbox"/>	<input type="checkbox"/>	<input type="checkbox"/>	<input type="checkbox"/>	<input type="checkbox"/>	<input type="checkbox"/>	<input type="checkbox"/>	£890
<b>COMFORT PLUS PACKAGE</b> – Comfort Package – Lumbar support, front – Seat adjustment – front, electric with driver memory	<input type="checkbox"/>	<input type="checkbox"/>	<input type="checkbox"/>	<input type="checkbox"/>	<input type="checkbox"/>	<input type="checkbox"/>	<input type="checkbox"/>	<input type="checkbox"/>	<input type="checkbox"/>	<input type="checkbox"/>	<input type="checkbox"/>	<input type="checkbox"/>	<input type="checkbox"/>	£1,950
<b>M SPORT PLUS PACKAGE</b> For M Sport models comprises: – 20" M light alloy Double-spoke style 699 M wheels, Bicolour Orbit Grey – Active Protection – Adaptive suspension – Extended High-gloss Shadowline – M seat belts – M Sport braking system, High-gloss Blue – Sun protection glass – Variable sport steering Alternative content – M Sport braking system, High-gloss Red	-	-	<input type="checkbox"/>	-	-	-	-	-	<input type="checkbox"/>	-	-	-	-	£2,200
– 21" BMW Individual light alloy V-spoke style 726 wheels, Bicolour Orbit Grey, with run-flat tyres	-	-	-	-	-	<input type="checkbox"/>	-	-	-	-	-	<input type="checkbox"/>	-	£1,700
For M40i / M40d models comprises: – 21" M light alloy Double-spoke style 718 M wheels, Cerium Grey matt, with run-flat tyres – Active Protection – Adaptive M suspension – Extended High-gloss Shadowline <sup>1</sup> – Lumbar support, driver and front passenger – M seat belts – M seats <sup>2</sup>	-	-	-	-	-	-	<input type="checkbox"/>	-	-	-	-	-	<input type="checkbox"/>	£2,400
	-	-	<input type="checkbox"/>	-	-	-	-	-	-	-	-	-	-	£300 pack alternative
	-	-	<input type="checkbox"/>	-	-	<input type="checkbox"/>	-	-	<input type="checkbox"/>	-	-	<input type="checkbox"/>	-	£690 pack alternative

/ = Indicates 'or'. <sup>1</sup> = Deselectable if Cerium Grey elements are preferred. <sup>2</sup> = Only with Vernasca leather in Black with Blue contrast stitching or Cognac with Mocha contrast stitching upholstery.



	xDrive20i SE	xDrive20i xLine	xDrive20i M Sport	xDrive30e SE	xDrive30e xLine	xDrive30e M Sport	M40i	xDrive20d SE	xDrive20d xLine	xDrive20d M Sport	xDrive30d SE	xDrive30d xLine	xDrive30d M Sport	M40d	Price
--	--------------	-----------------	-------------------	--------------	-----------------	-------------------	------	--------------	-----------------	-------------------	--------------	-----------------	-------------------	------	-------

PACKAGES (CONT.)

<b>TECHNOLOGY PACKAGE</b> Comprises: – BMW Gesture Control – Enhanced Bluetooth with wireless charging – Head-up Display – Loudspeaker system – harman/kardon – WiFi hotspot preparation	-	-	□	-	-	□	□	-	-	□	-	-	□	□	£1,900
<b>VISIBILITY PACKAGE</b> Comprises: – BMW Icon Adaptive LED Headlights – High-beam Assistant	□	□	□	□	□	□	■	□	□	□	□	□	□	■	£495

INTERIOR TRIMS

High-gloss Black with Pearl Chrome finisher	■	■	-	■	■	-	-	■	■	-	■	■	-	-	Std
Aluminium Rhombicle with Pearl Chrome finisher	-	-	■	-	-	■	■	-	-	■	-	-	■	■	Std
Aluminium fine cutting with Pearl Chrome finisher	□	□	-	□	□	-	-	□	□	-	□	□	-	-	£80
	-	-	□	-	-	□	□	-	-	□	-	-	□	□	£0
Carbon Fibre	-	-	-	-	-	-	□	-	-	-	-	-	-	□	£600
Dark Oak Wood, High-gloss with Pearl Chrome finisher	□	□	-	□	□	-	-	□	□	-	□	□	-	-	£230
	-	-	□	-	-	□	□	-	-	□	-	-	□	□	£150
Poplar grain Grey fine-wood with Pearl Chrome finisher	□	□	-	□	□	-	-	□	□	-	□	□	-	-	£230
	-	-	□	-	-	□	□	-	-	□	-	-	□	□	£150

BMW INDIVIDUAL INTERIOR TRIM

Piano Black	-	-	□	-	-	□	□	-	-	□	-	-	□	□	£500
-------------	---	---	---	---	---	---	---	---	---	---	---	---	---	---	------



	xDrive20i SE	xDrive20i xLine	xDrive20i M Sport	xDrive30e SE	xDrive30e xLine	xDrive30e M Sport	M40i	xDrive20d SE	xDrive20d xLine	xDrive20d M Sport	xDrive30d SE	xDrive30d xLine	xDrive30d M Sport	M40d	Price
--	--------------	-----------------	-------------------	--------------	-----------------	-------------------	------	--------------	-----------------	-------------------	--------------	-----------------	-------------------	------	-------

SAFETY & TECHNOLOGY

Active Cruise Control (ACC) with Stop&Go function Only with Galvanic embellisher for controls	<input type="checkbox"/>	<input type="checkbox"/>	<input type="checkbox"/>	<input type="checkbox"/>	<input type="checkbox"/>	<input type="checkbox"/>	<input type="checkbox"/>	<input type="checkbox"/>	<input type="checkbox"/>	<input type="checkbox"/>	<input type="checkbox"/>	<input type="checkbox"/>	<input type="checkbox"/>	<input type="checkbox"/>	£620
Driving Assistant Comprises: – Approach Control warning – Crossing-traffic warning, rear – Lane Change warning – Lane Departure warning – Prevention of rear collision – Speed Limit Info	<input type="checkbox"/>	<input type="checkbox"/>	<input type="checkbox"/>	<input type="checkbox"/>	<input type="checkbox"/>	<input type="checkbox"/>	<input type="checkbox"/>	<input type="checkbox"/>	<input type="checkbox"/>	<input type="checkbox"/>	<input type="checkbox"/>	<input type="checkbox"/>	<input type="checkbox"/>	<input type="checkbox"/>	£670
Driving Assistant Plus Comprises all functionality of Driving Assistant, plus: – Active Cruise Control (ACC) with Stop&Go function – Crossroads Warning – Crossing Traffic Warning, front – Evasion aid – Lane Change Assistant – Lane Keeping Assistant with active side collision protection – Steering and Lane Control Assistant – Wrong-way Warning Only with Galvanic embellisher for controls	<input type="checkbox"/>	<input type="checkbox"/>	<input type="checkbox"/>	<input type="checkbox"/>	<input type="checkbox"/>	<input type="checkbox"/>	<input type="checkbox"/>	<input type="checkbox"/>	<input type="checkbox"/>	<input type="checkbox"/>	<input type="checkbox"/>	<input type="checkbox"/>	<input type="checkbox"/>	<input type="checkbox"/>	£1,750
Larger fuel tank Increased to 68 litres	-	-	-	-	-	-	-	<input type="checkbox"/>	<input checked="" type="checkbox"/>	<input checked="" type="checkbox"/>	<input checked="" type="checkbox"/>	<input checked="" type="checkbox"/>	<input checked="" type="checkbox"/>	<input checked="" type="checkbox"/>	£40
Parking Assistant – Parking Assistant for parallel and lateral parking spaces – Active Park Distance Control – Reversing Assist camera	<input checked="" type="checkbox"/>	<input checked="" type="checkbox"/>	<input checked="" type="checkbox"/>	<input checked="" type="checkbox"/>	<input checked="" type="checkbox"/>	<input checked="" type="checkbox"/>	<input checked="" type="checkbox"/>	<input checked="" type="checkbox"/>	<input checked="" type="checkbox"/>	<input checked="" type="checkbox"/>	<input checked="" type="checkbox"/>	<input checked="" type="checkbox"/>	<input checked="" type="checkbox"/>	<input checked="" type="checkbox"/>	Std
Parking Assistant Plus Comprises all functionality of Parking Assistant, plus: – Remote 3D View – Surround View	<input type="checkbox"/>	<input type="checkbox"/>	<input type="checkbox"/>	<input type="checkbox"/>	<input type="checkbox"/>	<input type="checkbox"/>	<input type="checkbox"/>	<input type="checkbox"/>	<input type="checkbox"/>	<input type="checkbox"/>	<input type="checkbox"/>	<input type="checkbox"/>	<input type="checkbox"/>	<input type="checkbox"/>	£500
Run-flat tyres	-	<input type="checkbox"/>	<input type="checkbox"/>	-	<input type="checkbox"/>	<input type="checkbox"/>	<input type="checkbox"/>	-	<input type="checkbox"/>	<input type="checkbox"/>	-	<input type="checkbox"/>	<input type="checkbox"/>	<input type="checkbox"/>	£0

Only with = these options must be ordered together.

Standard equipment    Optional equipment   - Not available



	xDrive20i SE	xDrive20i xLine	xDrive20i M Sport	xDrive30e SE	xDrive30e xLine	xDrive30e M Sport	M40i	xDrive20d SE	xDrive20d xLine	xDrive20d M Sport	xDrive30d SE	xDrive30d xLine	xDrive30d M Sport	M40d	Price
--	--------------	-----------------	-------------------	--------------	-----------------	-------------------	------	--------------	-----------------	-------------------	--------------	-----------------	-------------------	------	-------

### EXTERIOR EQUIPMENT

Exterior trim, High-gloss Shadowline	<input type="checkbox"/>	<input type="checkbox"/>	<input checked="" type="checkbox"/>	<input type="checkbox"/>	<input type="checkbox"/>	<input checked="" type="checkbox"/>	<input checked="" type="checkbox"/>	<input type="checkbox"/>	<input type="checkbox"/>	<input checked="" type="checkbox"/>	<input type="checkbox"/>	<input type="checkbox"/>	<input checked="" type="checkbox"/>	<input checked="" type="checkbox"/>	£530
Exterior trim, Satin Aluminium	<input type="checkbox"/>	<input checked="" type="checkbox"/>	-	<input type="checkbox"/>	<input checked="" type="checkbox"/>	-	-	<input type="checkbox"/>	<input checked="" type="checkbox"/>	-	<input type="checkbox"/>	<input checked="" type="checkbox"/>	-	-	£310
M Sport braking system, High-gloss Red Only with M Sport Plus Package	-	-	<input type="checkbox"/>	-	-	<input type="checkbox"/>	<input checked="" type="checkbox"/>	-	-	<input type="checkbox"/>	-	-	<input type="checkbox"/>	<input checked="" type="checkbox"/>	£300
Towbar, fully electric	<input type="checkbox"/>	<input type="checkbox"/>	<input type="checkbox"/>	<input type="checkbox"/>	<input type="checkbox"/>	<input type="checkbox"/>	<input type="checkbox"/>	<input type="checkbox"/>	<input type="checkbox"/>	<input type="checkbox"/>	<input type="checkbox"/>	<input type="checkbox"/>	<input type="checkbox"/>	<input type="checkbox"/>	£850

### INTERIOR EQUIPMENT

Extended storage Included in Comfort Package / Comfort Plus Package	<input type="checkbox"/>	<input type="checkbox"/>	<input type="checkbox"/>	<input type="checkbox"/>	<input type="checkbox"/>	<input type="checkbox"/>	<input type="checkbox"/>	<input type="checkbox"/>	<input type="checkbox"/>	<input type="checkbox"/>	<input type="checkbox"/>	<input type="checkbox"/>	<input type="checkbox"/>	<input type="checkbox"/>	£190
Galvanic embellisher for controls	<input type="checkbox"/>	<input type="checkbox"/>	<input type="checkbox"/>	<input type="checkbox"/>	<input type="checkbox"/>	<input type="checkbox"/>	<input type="checkbox"/>	<input type="checkbox"/>	<input type="checkbox"/>	<input type="checkbox"/>	<input type="checkbox"/>	<input type="checkbox"/>	<input type="checkbox"/>	<input type="checkbox"/>	£110
Instrument panel in Sensatec	-	<input type="checkbox"/>	<input type="checkbox"/>	-	<input type="checkbox"/>	<input type="checkbox"/>	<input checked="" type="checkbox"/>	-	<input type="checkbox"/>	<input type="checkbox"/>	-	<input type="checkbox"/>	<input type="checkbox"/>	<input checked="" type="checkbox"/>	£500
Panoramic glass sunroof	<input type="checkbox"/>	<input type="checkbox"/>	<input type="checkbox"/>	<input type="checkbox"/>	<input type="checkbox"/>	<input type="checkbox"/>	<input type="checkbox"/>	<input type="checkbox"/>	<input type="checkbox"/>	<input type="checkbox"/>	<input type="checkbox"/>	<input type="checkbox"/>	<input type="checkbox"/>	<input type="checkbox"/>	£1,190
Steering wheel heating	<input type="checkbox"/>	<input type="checkbox"/>	<input type="checkbox"/>	<input type="checkbox"/>	<input type="checkbox"/>	<input type="checkbox"/>	<input type="checkbox"/>	<input type="checkbox"/>	<input type="checkbox"/>	<input type="checkbox"/>	<input type="checkbox"/>	<input type="checkbox"/>	<input type="checkbox"/>	<input type="checkbox"/>	£170
Sun protection glass Included in M Sport Plus Package	<input type="checkbox"/>	<input type="checkbox"/>	<input type="checkbox"/>	<input type="checkbox"/>	<input type="checkbox"/>	<input type="checkbox"/>	<input checked="" type="checkbox"/>	<input type="checkbox"/>	<input type="checkbox"/>	<input type="checkbox"/>	<input type="checkbox"/>	<input type="checkbox"/>	<input type="checkbox"/>	<input checked="" type="checkbox"/>	£320

### SEATS

Lumbar support, front	<input type="checkbox"/>	<input type="checkbox"/>	<input type="checkbox"/>	<input type="checkbox"/>	<input type="checkbox"/>	<input type="checkbox"/>	<input type="checkbox"/>	<input type="checkbox"/>	<input type="checkbox"/>	<input type="checkbox"/>	<input type="checkbox"/>	<input type="checkbox"/>	<input type="checkbox"/>	<input type="checkbox"/>	£265
Seat heating, front and rear Only with Vernasca leather	<input type="checkbox"/>	<input type="checkbox"/>	<input type="checkbox"/>	<input type="checkbox"/>	<input type="checkbox"/>	<input type="checkbox"/>	<input type="checkbox"/>	<input type="checkbox"/>	<input type="checkbox"/>	<input type="checkbox"/>	<input type="checkbox"/>	<input type="checkbox"/>	<input type="checkbox"/>	<input type="checkbox"/>	£280

Only with = these options must be ordered together.

Standard equipment  Optional equipment - Not available



	xDrive20i SE	xDrive20i xLine	xDrive20i M Sport	xDrive30e SE	xDrive30e xLine	xDrive30e M Sport	M40i	xDrive20d SE	xDrive20d xLine	xDrive20d M Sport	xDrive30d SE	xDrive30d xLine	xDrive30d M Sport	M40d	Price
--	--------------	-----------------	-------------------	--------------	-----------------	-------------------	------	--------------	-----------------	-------------------	--------------	-----------------	-------------------	------	-------

AUDIO & COMMUNICATION

BMW Emergency Call <sup>1</sup>	■	■	■	■	■	■	■	■	■	■	■	■	■	■	Std
BMW Live Cockpit Plus Comprises: – 5.7" Digital Instrument Display – 8.8" Control Display with Touch Functionality – BMW iDrive 6 System (iD6) – iDrive controller with Touch Function For further details, see <a href="#">BMW ConnectedDrive</a>	■	■	-	■	■	-	-	■	■	-	■	■	-	-	Std
BMW Live Cockpit Professional Comprises: – 10.25" Control Display with Touch Functionality – 12.3" Digital Instrument Display – BMW Operating System 7.0 – iDrive Controller with Touch Function For further details, see <a href="#">BMW ConnectedDrive</a>	-	-	■	-	-	■	■	-	-	■	-	-	■	■	Std
BMW Online Services <sup>2,3</sup> Comprises: – BMW Apps – BMW Online Services – Intelligent Voice Control – Last State Call <sup>1,3</sup> – USB and Over-the-air Map Updates	■	■	■	■	■	■	■	■	■	■	■	■	■	■	Std
BMW TeleServices <sup>1</sup>	■	■	■	■	■	■	■	■	■	■	■	■	■	■	Std

<sup>1</sup> = Available and active without runtime limitations. Usage cannot be guaranteed permanently due to potential future technical developments (of the Service availability and/or Smartphone compatibility/operating systems). <sup>2</sup> = Active for 3 years, renewable thereafter at an additional cost. <sup>3</sup> = Requires a free BMW ConnectedDrive account.



	xDrive20i SE	xDrive20i xLine	xDrive20i M Sport	xDrive30e SE	xDrive30e xLine	xDrive30e M Sport	M40i	xDrive20d SE	xDrive20d xLine	xDrive20d M Sport	xDrive30d SE	xDrive30d xLine	xDrive30d M Sport	M40d	Price
--	--------------	-----------------	-------------------	--------------	-----------------	-------------------	------	--------------	-----------------	-------------------	--------------	-----------------	-------------------	------	-------

AUDIO & COMMUNICATION (CONT.)

Connected Package Plus Comprises: – Apple CarPlay <sup>1,2</sup> – Concierge Services <sup>3,4</sup> – Real Time Traffic Information <sup>3,4</sup> – Remote 3D View <sup>5</sup> – Remote Services <sup>4</sup> For further details, see <a href="#">BMW ConnectedDrive</a>	■	■	-	■	■	-	-	■	■	-	-	■	■	-	Std
Connected Package Professional Comprises the full functionality of Connected Package Plus, as well as: – BMW Maps <sup>3,4</sup> – Connected Charging <sup>3,6</sup> – Connected Music <sup>3,4</sup> – Connected Parking <sup>3,4</sup> – Connected Teaser <sup>7,8</sup> – Smartphone Integration <sup>1,2</sup> For further details, see <a href="#">BMW ConnectedDrive</a>	-	-	■	-	-	■	■	-	-	■	■	-	-	■	Std
DAB tuner	■	■	■	■	■	■	■	■	■	■	■	■	■	■	Std
Enhanced Bluetooth with wireless charging Included in Technology Package Only with WiFi hotspot preparation	□	□	□	□	□	□	□	□	□	□	□	□	□	□	£430
Loudspeaker system – harman/kardon Included in Technology Package	-	-	□	-	-	□	□	-	-	□	-	-	□	□	£820
WiFi hotspot preparation <sup>9</sup> Included in Technology Package Only with Enhanced Bluetooth with wireless charging	□	□	□	□	□	□	□	□	□	□	□	□	□	□	£0

Only with = these options must be ordered together. <sup>1</sup> = Available and active without runtime limitations. Usage cannot be guaranteed permanently due to potential future technical developments (of the Service availability and/or Smartphone compatibility/operating systems). <sup>2</sup> = Functions using a data connection will use data from the SIM card in the phone. Additional data charges may be applied by the mobile network provider. Compatibility and functions may vary due to the make and model year of the phone and the version of software installed on it. <sup>3</sup> = Requires a free BMW ConnectedDrive account. <sup>4</sup> = Active for 3 years, renewable thereafter at an additional cost. <sup>5</sup> = Only in combination with Parking Assistant Plus. <sup>6</sup> = Exclusively available on xDrive30e models for three years. <sup>7</sup> = Includes BMW Music. For further details, see [BMW ConnectedDrive](#). <sup>8</sup> = Available and active for three months. Can be extended or renewed thereafter at an extra cost. <sup>9</sup> = Data subscription costs apply and must be purchased separately.



xDrive20i SE	xDrive20i xLine	xDrive20i M Sport	xDrive30e SE	xDrive30e xLine	xDrive30e M Sport	M40i	xDrive20d SE	xDrive20d xLine	xDrive20d M Sport	xDrive30d SE	xDrive30d xLine	xDrive30d M Sport	M40d	Snow chains	Run-flat tyres <sup>1</sup>	Price
--------------	-----------------	-------------------	--------------	-----------------	-------------------	------	--------------	-----------------	-------------------	--------------	-----------------	-------------------	------	-------------	-----------------------------	-------

LIGHT ALLOY WHEELS

	18" V-spoke style 618	■	-	-	-	-	-	■	-	-	-	-	-	□	-	Std
	18" Double-spoke style 688	□	-	-	■	-	-	□	-	-	■	-	-	□	-	£110
	19" V-spoke style 692, Bicolour Ferric Grey	□	-	-	□	-	-	□	-	-	□	-	-	□	-	£935
	19" Y-spoke style 694, Ferric Grey	-	■	-	-	■	-	-	■	-	-	■	-	□	-	Std
	19" M Double-spoke style 698 M, Bicolour Ferric Grey	-	-	■	-	-	■	-	-	■	-	■	-	□	-	Std





<sup>1</sup> = Mobility kit is standard where run-flat tyres are not available. BMW Winter Tyre Packages available on BMW X3. Please contact your local BMW Centre for more information.

■ Standard equipment □ Optional equipment - Not available



xDrive20i SE	xDrive20i xLine	xDrive20i M Sport	xDrive30e SE	xDrive30e xLine	xDrive30e M Sport	M40i	xDrive20d SE	xDrive20d xLine	xDrive20d M Sport	xDrive30d SE	xDrive30d xLine	xDrive30d M Sport	M40d	Snow chains	Run-flat tyres <sup>1</sup>	Price
--------------	-----------------	-------------------	--------------	-----------------	-------------------	------	--------------	-----------------	-------------------	--------------	-----------------	-------------------	------	-------------	-----------------------------	-------

LIGHT ALLOY WHEELS

	20" Y-spoke style 695, Bicolour Orbit Grey	-	□	-	-	□	-	-	□	-	-	-	-	-	-	£1,020
	20" M Double-spoke style 699 M, Bicolour Orbit Grey	-	-	□	-	-	□	■	-	□	-	□	■	-	-	n/a
	Only with M Sport Plus Package															
	21" M Double-spoke style 718 M, Cerium Grey Matt	-	-	-	-	-	-	-	-	-	-	-	□	-	■	n/a
	Only with M Sport Plus Package															
	21" BMW Individual V-spoke style 726, Bicolour Orbit Grey	-	□	□	-	□	□	-	-	□	□	□	-	-	■	£1,400
	In conjunction with M Sport Plus Package	-	-	□	-	-	□	-	-	□	-	□	-	-	■	£690

<sup>1</sup> = Mobility kit is standard where run-flat tyres are not available. BMW Winter Tyre Packages available on BMW X3. Please contact your local BMW Centre for more information.

■ Standard equipment □ Optional equipment - Not available





### 360° ELECTRIC

	xDrive30e SE	xDrive30e xLine	xDrive30e M Sport	Price
Digital Charging Service – 12 months subscription <sup>1</sup>	■	■	■	n/a
Home charging: BMW i Wallbox Connect (32 Amp) with Standard Installation <sup>2</sup>	□	□	□	From £975+
Public Charging: BMW i AC Rapid Charge Cable (5 metre length) – Max 32 Amp 3-phase public charging cable, Type 2 connectors	■	■	■	n/a
Public Charging: BMW i AC Fast Charge Cable (8 metre length) – Max 32 Amp 1-phase public charging cable, Type 2 connectors	□	□	□	£195
Public charging: ChargeNow – Pay as you go charging <sup>3</sup>	□	□	□	£7.85 per month
Assistance Services – BMW i Mobile Care – Battery Warranty – Vehicle Warranty	■	■	■	n/a



+ = Subject to OLEV subsidy and qualification which may be liable to change, for further details please speak to your local BMW Centre. For more information about Plug-In Hybrid Electric Vehicles please visit [here](#). <sup>1</sup> = 12 months subscription from production date only, renewable thereafter for £45 per annum via the ConnectedDrive Store. <sup>2</sup> = Includes 3 year warranty. <sup>3</sup> = Available as a stand alone service. Terms and Conditions apply, find out more at [here](#). The design of the charging cable may vary from image shown. Content correct at time of publishing. Prices subject to change.

# DIMENSIONS.

## THE BMW X3.

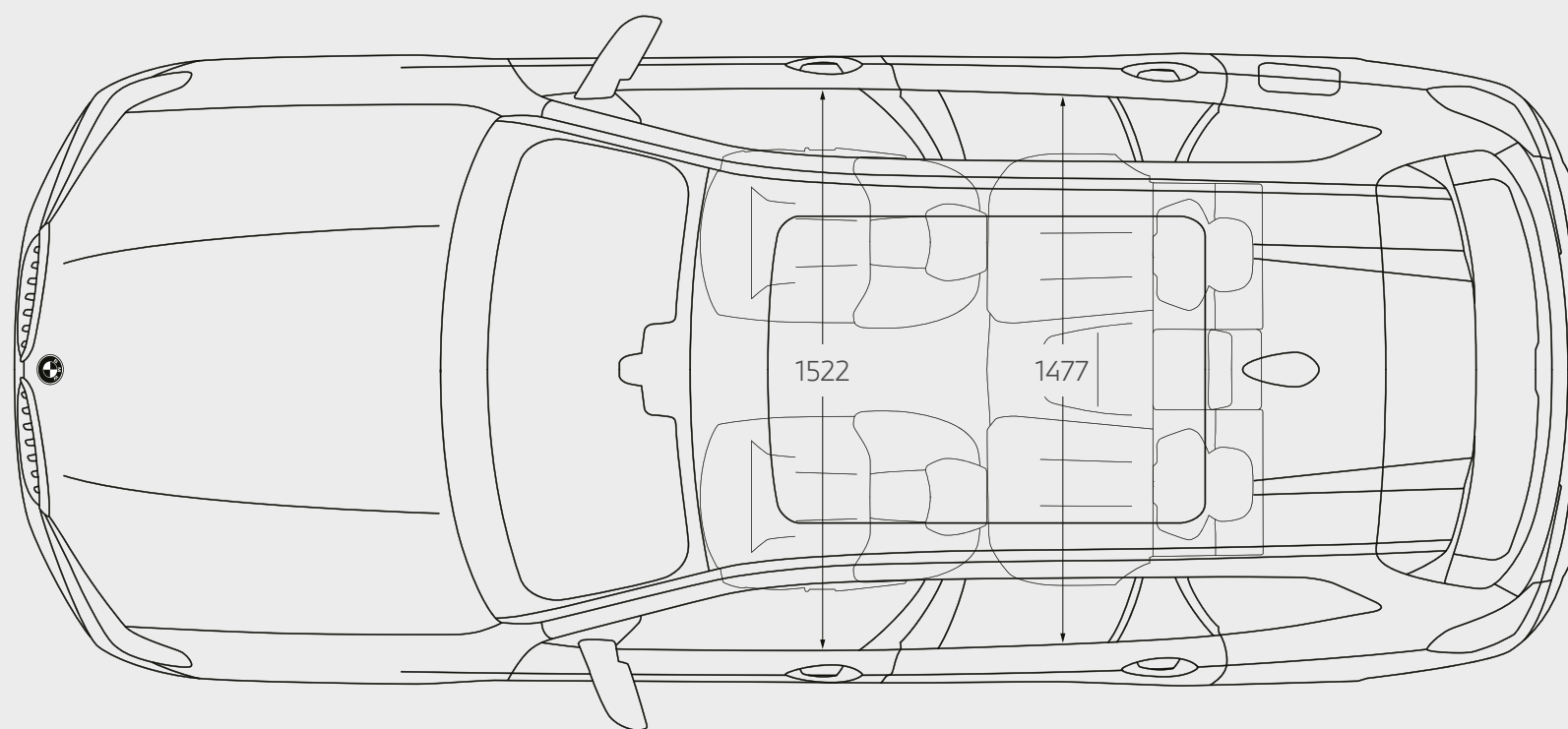
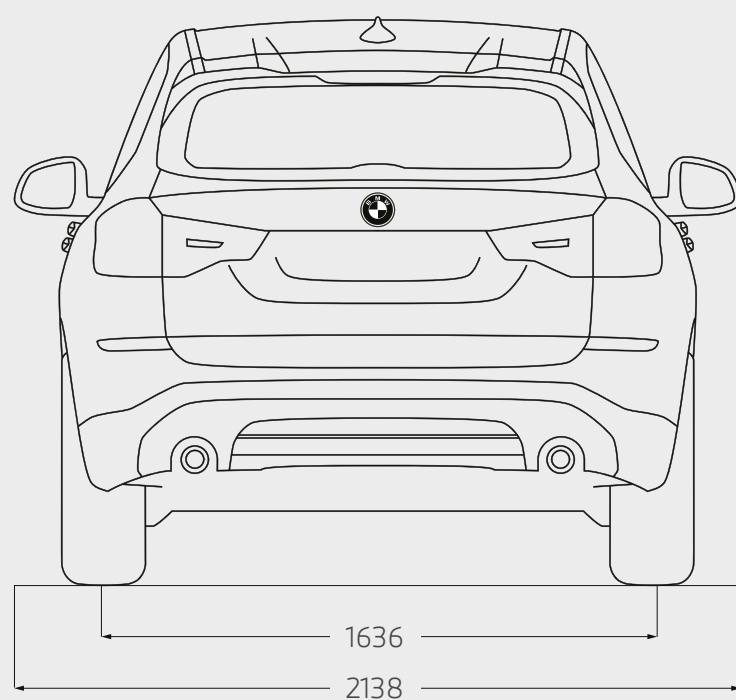
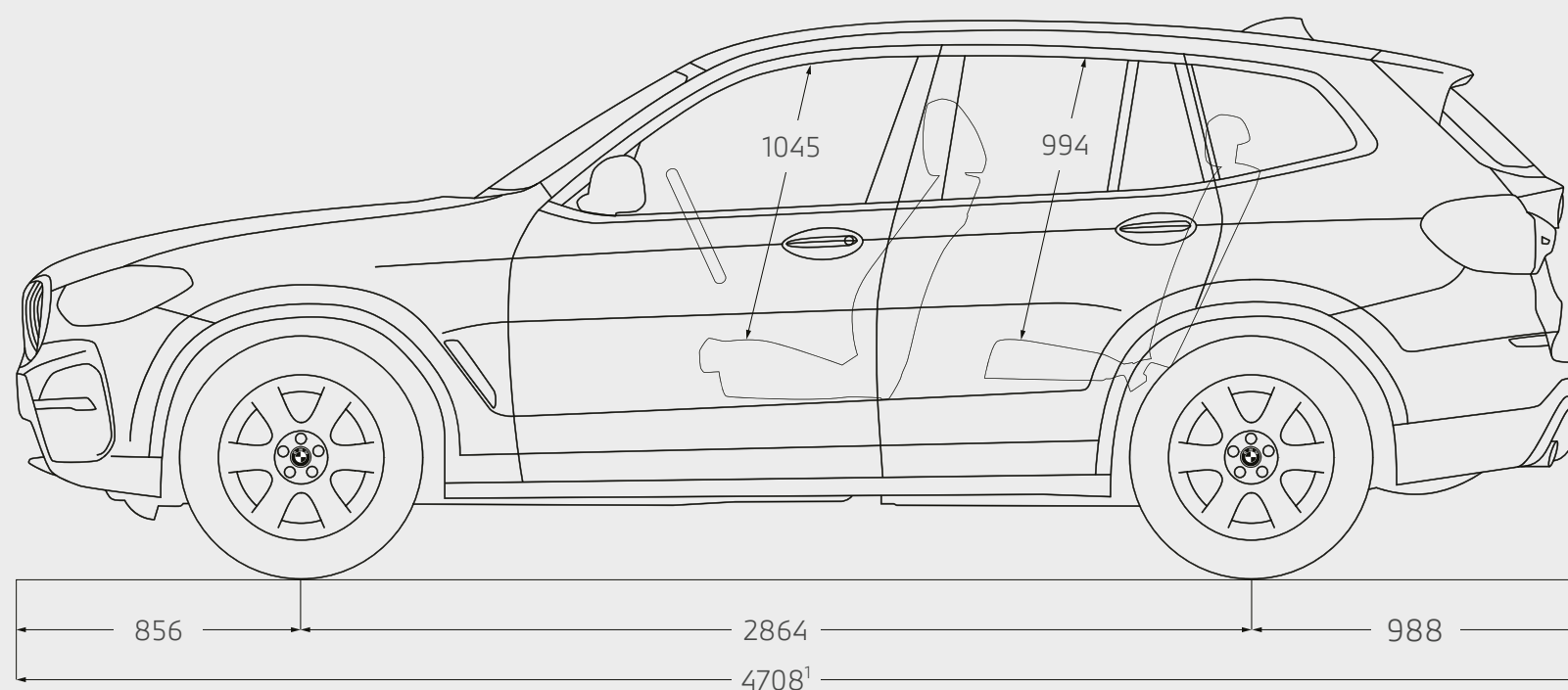
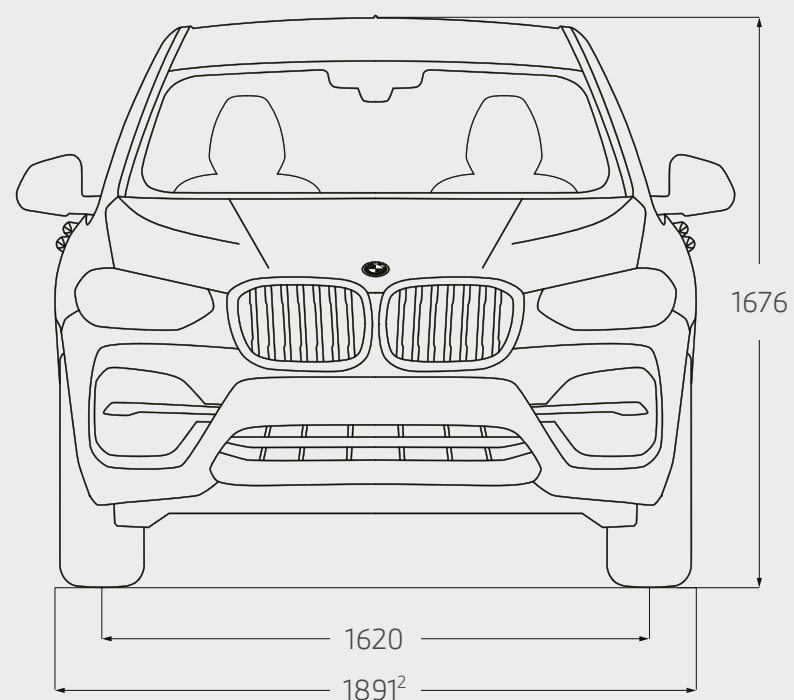

Length (mm)	4708 <sup>1</sup>	Height (mm)	1676	Number of seats	5	Turning circle (m)	12.0 <sup>3</sup>
Width (mm)	1891 <sup>2</sup>	Width including mirrors (mm) (Driver / Passenger)	2138 (1080 / 1058)	Wheelbase (mm)	2864	Luggage capacity (litre)	550-1600 <sup>4</sup>

<sup>1</sup> = M40i/d: 4716mm. <sup>2</sup> = M40i/d: 1897mm. <sup>3</sup> = M40i/d: 12.1m. <sup>4</sup> = xDrive30e: 450-1500 litres.

# BMW PAY MONTHLY SERVICING & TRACKSTAR.

## SERVICING MADE SIMPLE.

Planning for the road ahead has never been easier. With the BMW Pay Monthly Service Plan<sup>1</sup> you can remove the uncertainty often associated with car servicing costs by spreading them monthly, much like you would your household bills. Our Pay Monthly service plan covers two services and any unused credit can be transferred to another BMW if you decide to switch unexpectedly. As part of the Pay Monthly plan you will also receive a number of added extras including:

- Fluid top ups
- An MOT
- A Wash & Vac each time you visit
- Seasonal health checks
- Sat Nav Map updates

Get the quality service and parts you expect from BMW with a fixed monthly payment. Give your BMW the care and attention it deserves from the experts that made it.

**Price: £25 per month for 36 months**

Please contact your preferred BMW Centre for further information.

## BMW TRACKSTAR.

Locate and recover your vehicle if it is stolen with BMW Trackstar or BMW Trackstar Advance. Benefits include:

- 24/7 Trackstar Monitoring Centre
- Thatcham accredited
- Integrated motion sensor
- Pan-European protection

**BMW Trackstar S7 price from: £399<sup>2</sup>**

**BMW Trackstar S5 price from £549<sup>2</sup>**

**BMW Trackstar S5 Advance price from: £649<sup>2</sup>**



# BMW CONNECTED DRIVE SERVICES.

BMW ConnectedDrive keeps driver and vehicle connected with the outside world. Digital services, driver-focused technologies and driver assistance systems provide more comfort, more entertainment and more safety. Increase your driving pleasure – with BMW ConnectedDrive.

For further information on BMW ConnectedDrive and the General Terms and Conditions of Service for ConnectedDrive, please see: [www.bmw.co.uk/connecteddrive-information](http://www.bmw.co.uk/connecteddrive-information)

The BMW ConnectedDrive Hotline is available on: +44 (0) 800 561 0555 from Monday to Friday 8am – 7pm and Saturday to Sunday 9am – 5pm.

## CONNECTED DRIVE SERVICES DURATION

BMW Music	3 month trial
BMW Apps	3 years
BMW Maps	3 years
BMW Online Services	3 years
Concierge Services	3 years
Connected Charging (xDrive30e only)	3 years
Connected Music	3 years
Connected Parking	3 years
Intelligent Voice Control	3 years
Map Updates	3 years
Real Time Traffic Information	3 years
Remote Services	3 years
Apple CarPlay® Preparation	Active without runtime limitations
BMW Emergency Call	Active without runtime limitations
BMW TeleServices	Active without runtime limitations
Last State Call	Active without runtime limitations
Smartphone Integration	Active without runtime limitations

## GENERAL INFORMATION

BMW (UK) Ltd, Summit ONE, Summit Avenue, Farnborough, Hampshire, GU14 0FB (hereinafter referred to as "BMW") provides the customer with certain vehicle-related information and assistance functions (hereinafter called "Services") under the name of "BMW ConnectedDrive". BMW collects, stores or processes car-related data in compliance with applicable law and only to the extent necessary to provide the Services. BMW does not collect, store or process personal data in course of the Services – except where this is explicitly stated in the service description of the individual Services. In the case of Services that require personal data to be collected, stored and processed so that such Services can actually be provided, BMW informs customers of this in advance by providing this data protection notice. The Services are provided by means of a SIM card installed in the vehicle.

## DEACTIVATION

You can have the BMW ConnectedDrive services deactivated through an authorised BMW centre, a BMW subsidiary or a BMW authorised workshop at any time. This also has the consequence that aspects of the emergency call in the vehicle as well as all remaining Services will no longer function.

You can additionally arrange for the remaining Services to be deactivated via "My BMW ConnectedDrive". If the vehicle is equipped with the legally required EU Emergency Call (as from April 2018) a deactivation of the BMW ConnectedDrive basic services will not deactivate the vehicle's built-in SIM card. It has to remain active, so that the EU Emergency Call is functional all the time.

Services that are available and active without runtime limitations, cannot be guaranteed for permanent usage due to potential future technical developments (of the Service availability and/or Smartphone compatibility/operating systems).





READY TO TAKE THE NEXT STEP?